

HAMAMATSU

PHOTON IS OUR BUSINESS

EXCIMER LAMP LIGHT SOURCE

FLAT EXCIMER™

Modification

Cleaning

Bonding



HAMAMATSU PHOTONICS K.K.

Modification

Surface modification technology is utilized in a wide range of industrial fields. Compared to ordinary techniques, material modification using excimer lamps is considered precision modification because it occurs via a chemical reaction on the atomic or molecular level. Moreover, this is clean modification that does not harm the material and generates no dust particles, and so is effective in fields requiring more advanced levels of material modification.

RESULTS

* Data verified by in-house testing.

■ Surface modification of various materials

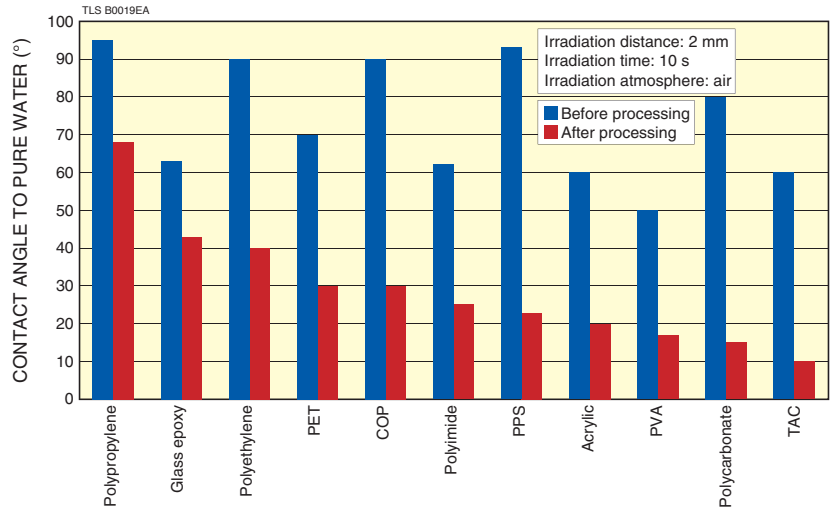

■ Surface modification of resin

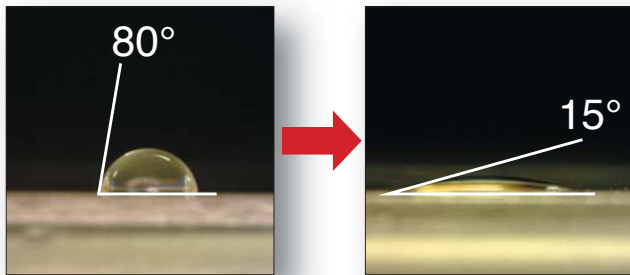

Before excimer light irradiation

After excimer light irradiation

■ Bonding pre-processing (improve adhesiveness)

Example: Polyphenylene sulfide (PPS) + polyolefin (PO)

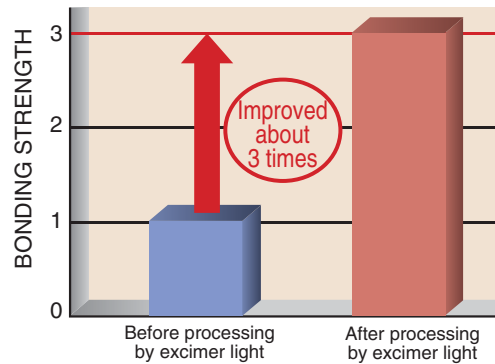

TLS B0013EA

PRINCIPLE

1

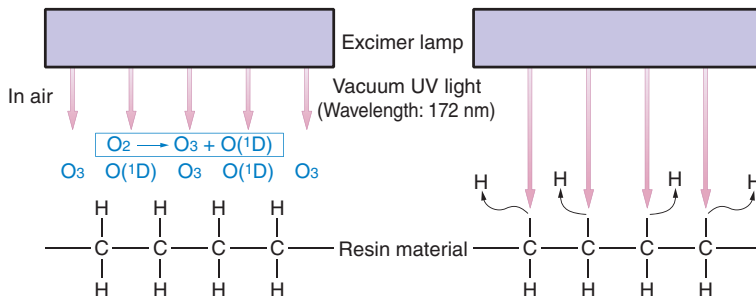

Vacuum UV light at a wavelength of 172 nm generates ozone and active oxygen in large quantities.

Bonds in material surface are simultaneously broken up by vacuum UV light.

2

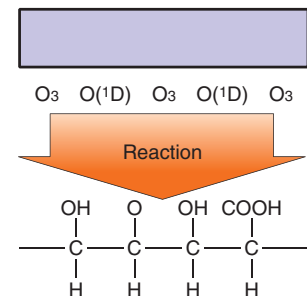

Imparts hydrophilicity to the material surface since chemical reaction forms functional groups on dangling bonds to provide functionality.

Expanding the possibilities of modification, cleaning, and bonding with light!

Cleaning

Vacuum UV light at a wavelength of 172 nm emitted from an excimer lamp is greatly absorbed by oxygen so that highly concentrated active oxygen can be generated. Vacuum UV light is also capable of breaking the molecular bonds of organic matter and so provides benefits in various processes such as accelerating the cleaning speed, improving the cleaning quality, and increasing the product yield.

RESULTS

Optical cleaning of evaporated gold coatings on laser mirrors

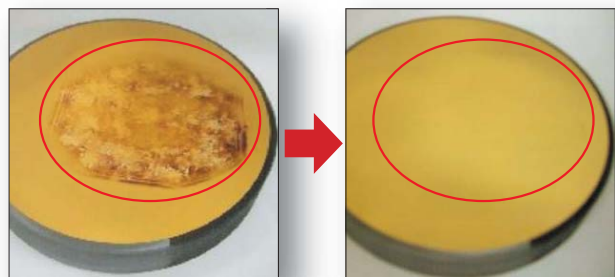

Before excimer light irradiation

After excimer light irradiation

Removal of acetone cleaning residues

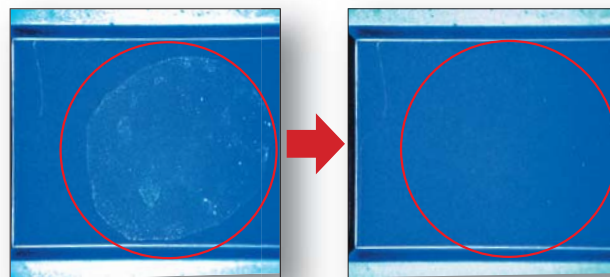

Before excimer light irradiation

After excimer light irradiation

* Data verified by in-house testing.

PRINCIPLE

1

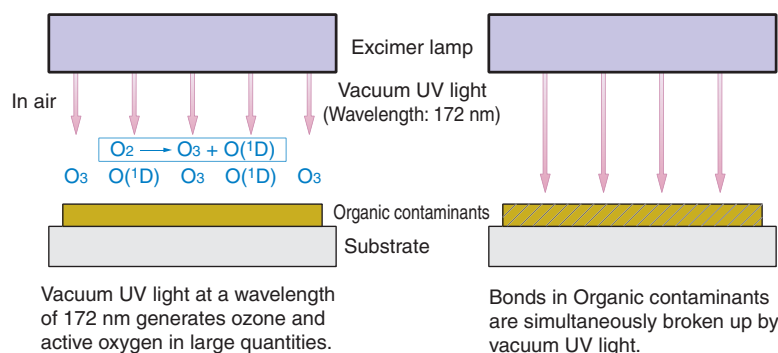

2

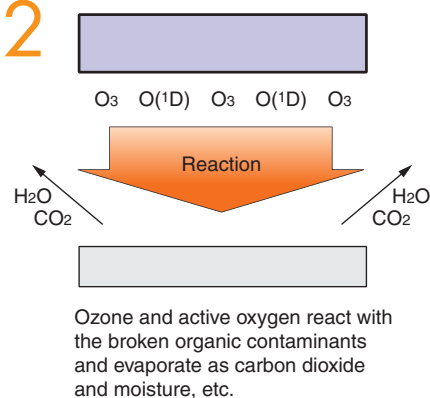

Bonding

Microfluidic devices are now actively used in various fields including medical and biological applications. The bonding technology used for such devices having fine structures requires bonding techniques with a still higher degree of quality and accuracy. Bonding that uses excimer lamps needs no adhesive agent and causes no damage and thermal deformation, making it ideal for bonding of microfluidic devices.

FLAT EXCIMER™

FEATURES

Comparison with other methods

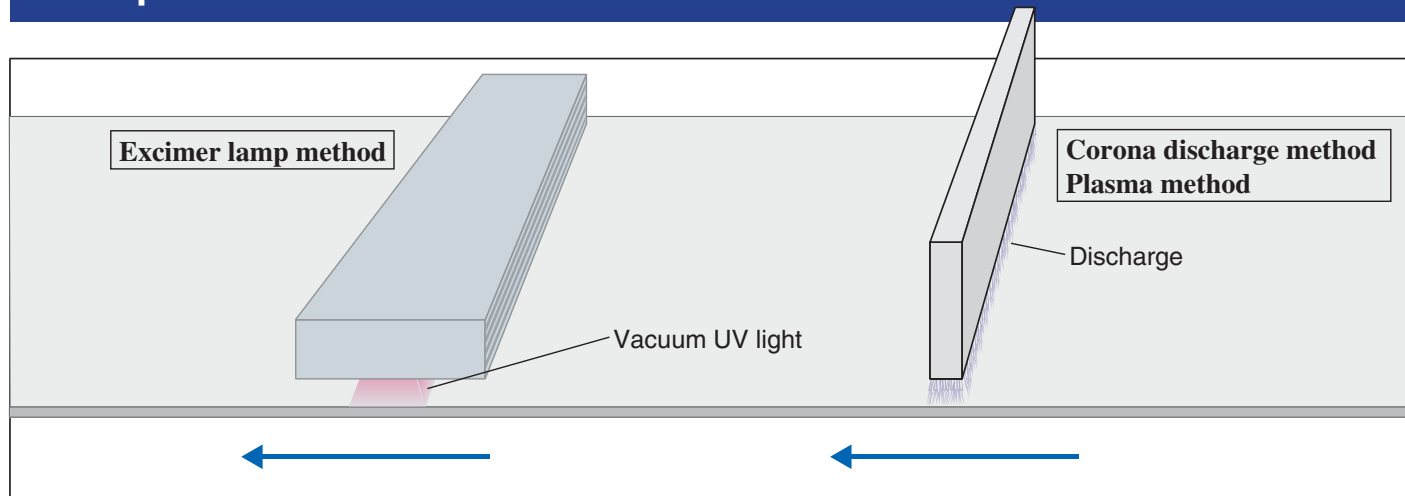

No damage to object

In the corona discharge and plasma methods, the target object is directly exposed to discharge and so may be damaged. In the excimer lamp method, however, the object is merely irradiated with vacuum UV light and so there will be no damage to it.

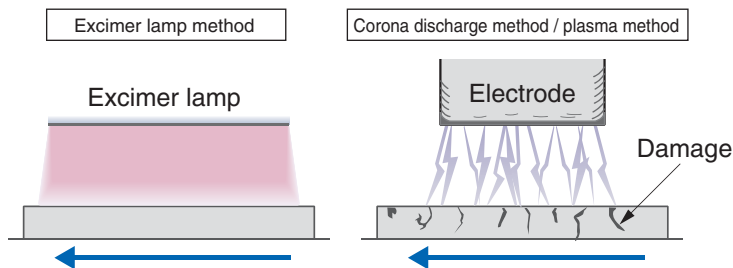

No dust particle generation

In the corona discharge and plasma methods, dust particles generated by electrode spattering might fly upward by air flow and adhere to the target object surface. The excimer lamp method solves these problems and ensures clean processing.

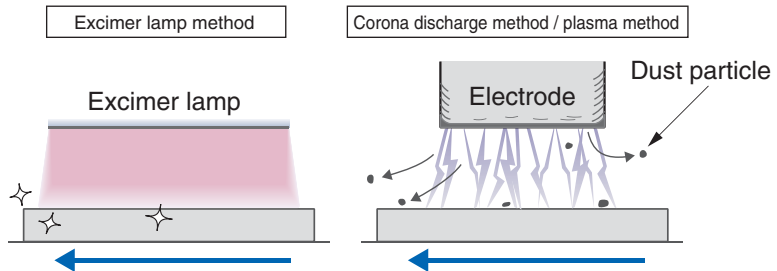

No processing irregularities

Unlike the corona discharge and plasma methods utilizing discharge, the excimer lamp method using light does not cause uneven irradiation and so achieves highly efficient, uniform processing over a large area.

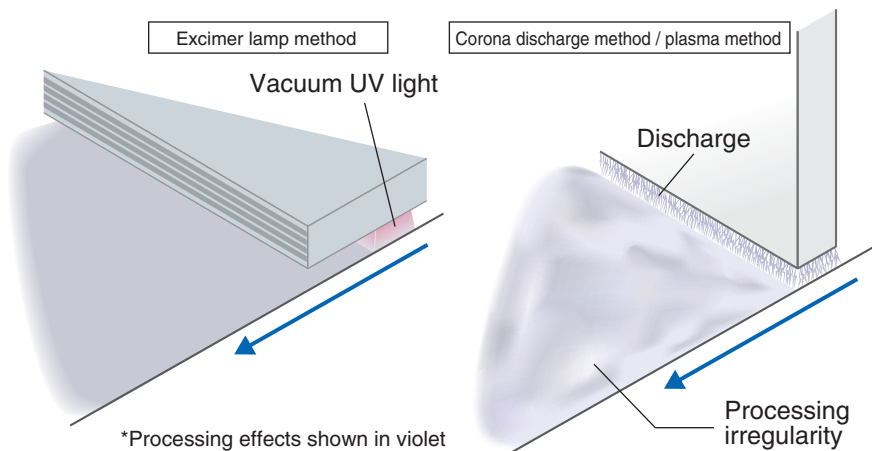

Comparison with other manufacturer's excimer lamps

Uniformly irradiates a large area by using a flat lamp

Uniformity characteristics (along short axis)
Flat lamp vs. cylindrical lamp

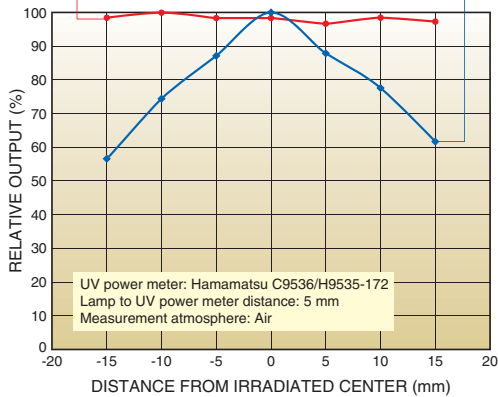
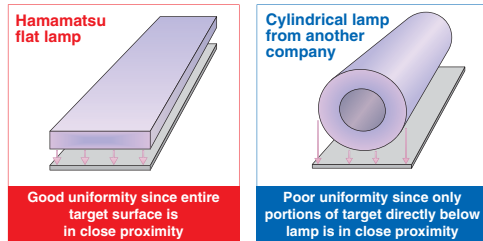

Irradiance distribution (Typical example)

Compact flat lamp (EX-86U, EX-mini) Actual size

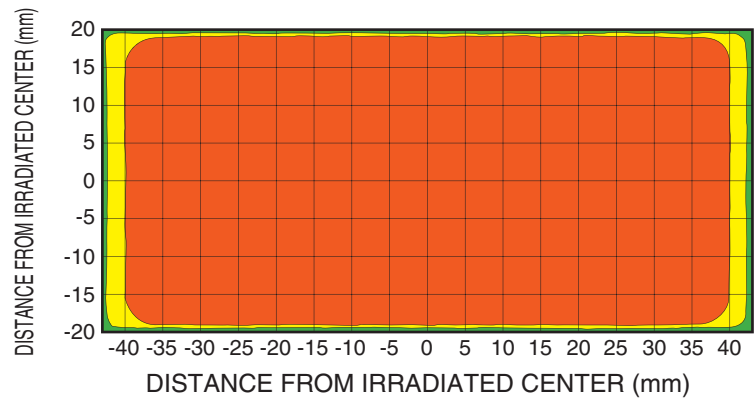

UV power meter: Hamamatsu C9536/H9535-172
Lamp to UV power meter distance: 5 mm
Measurement atmosphere: Air

Gives stable output with minimal flicker by using RF* discharge

RF discharge vs. dielectric barrier discharge

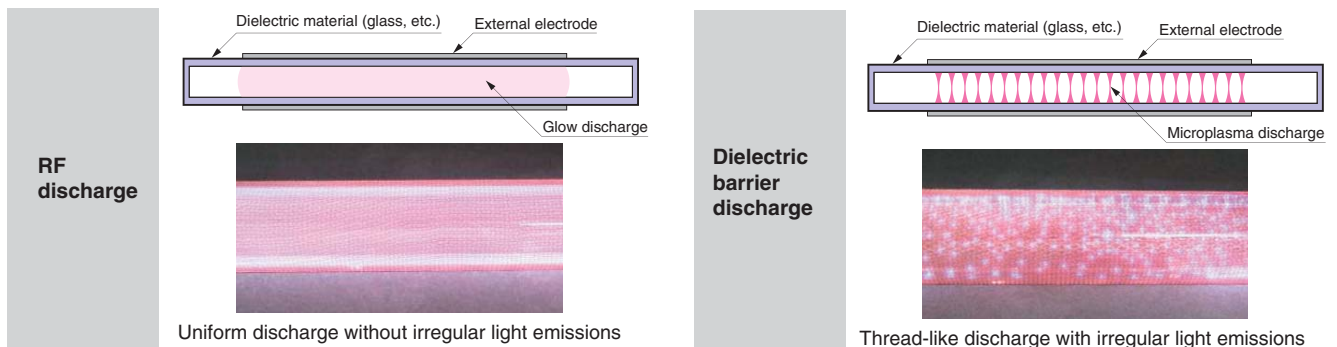

Power supply auto-tuning function for efficient light emission

Single wavelength at 172 nm allows highly efficient processing

Instantaneous lamp ON / OFF operation

Note: *RF indicates "radio frequency"

APPLICATION EXAMPLES

Modification

Surface modification using excimer lamps can be used to improve adhesion and improve the functionality of materials such as by making them hydrophilic and its applications are expanding in recent years to include a wide range of fields and materials.

- Improvement of adhesiveness during printing and coating

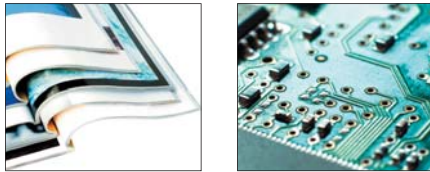

- Improvement of adhesive strength during bonding
- Improvement of resist wettability
- Improvement of wettability in various materials such as resin, metal, and rubber

●Surface modification of devices

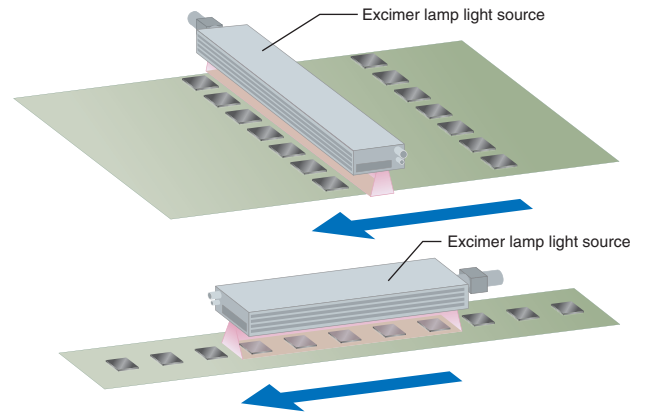

Cleaning

Cleaning is performed just by illuminating the material with light and so is especially effective on materials not compatible with wet cleaning or that are easily damaged by heat.

- Cleaning of silicon wafers and glass substrates

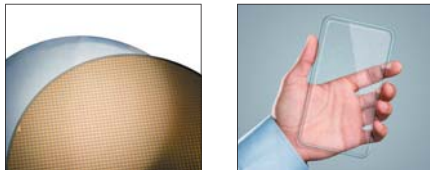

- Removal of resist residues, adhesive residues, organic films, and oil stains

●Glass substrate cleaning

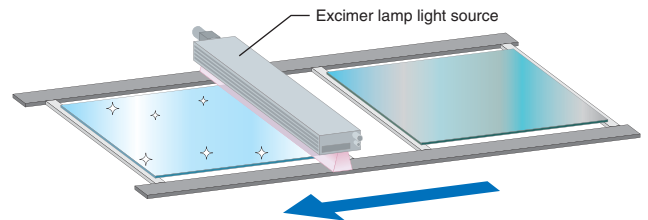

Bonding

Since bonding is carried out by surface activation using light, it does not damage materials, helps downsize equipment, reduces its cost, simplifies the process, and allows bonding only at the desired position.

This technique can be applied to various materials of microfluidic devices.

■Application fields where microfluidic devices are used

- Protein and DNA analysis
- Drug discovery support
- Cell experiments
- Chemical monitoring

●Bonding of microfluidic devices

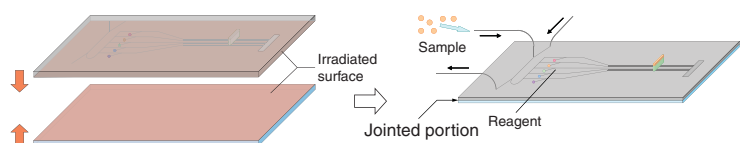

PRODUCT LINEUP

FLAT EXCIMER™ EX-400

■Irradiation area size
400 mm × 38 mm



Use of a flat long lamp and RF (radio frequency) discharge delivers stable output with uniform irradiation over a large area and less flickering.

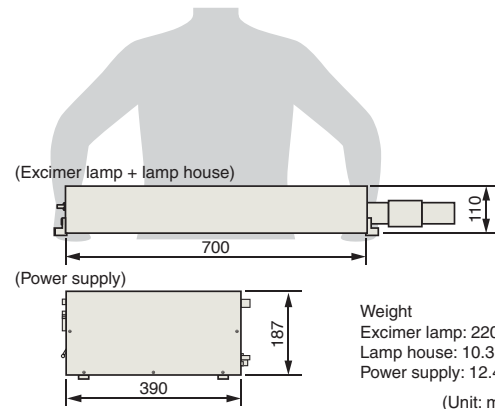

FLAT EXCIMER™ EX-86U

■Irradiation area size
86 mm × 40 mm



Compact all-in-one design with a built-in power supply eliminates the installation time and task. The EX-86U can be installed anywhere and easily set up in a production process.

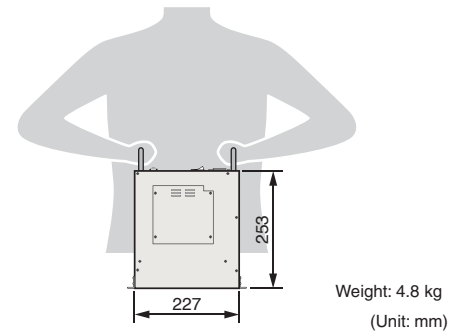

FLAT EXCIMER™ EX-mini

■Irradiation area size
86 mm × 40 mm



Amazingly handy and easy to use design allows simple yet highly accurate testing and evaluation in any place needed.

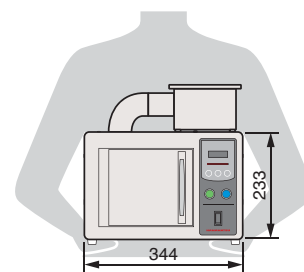

Ozone decomposition unit is optional.

FLAT EXCIMER™

EX-400

L11751-01 E12499 C13128



Excimer lamp with even higher uniformity

Use of a flat long lamp and RF (radio frequency) discharge delivers stable output with uniform irradiation over a large area and less flickering. The EX-400 ensures highly accurate, high quality modification, cleaning, and bonding compared to corona discharge method, plasma method, and even other excimer lamps.



INSTALLATION EXAMPLE

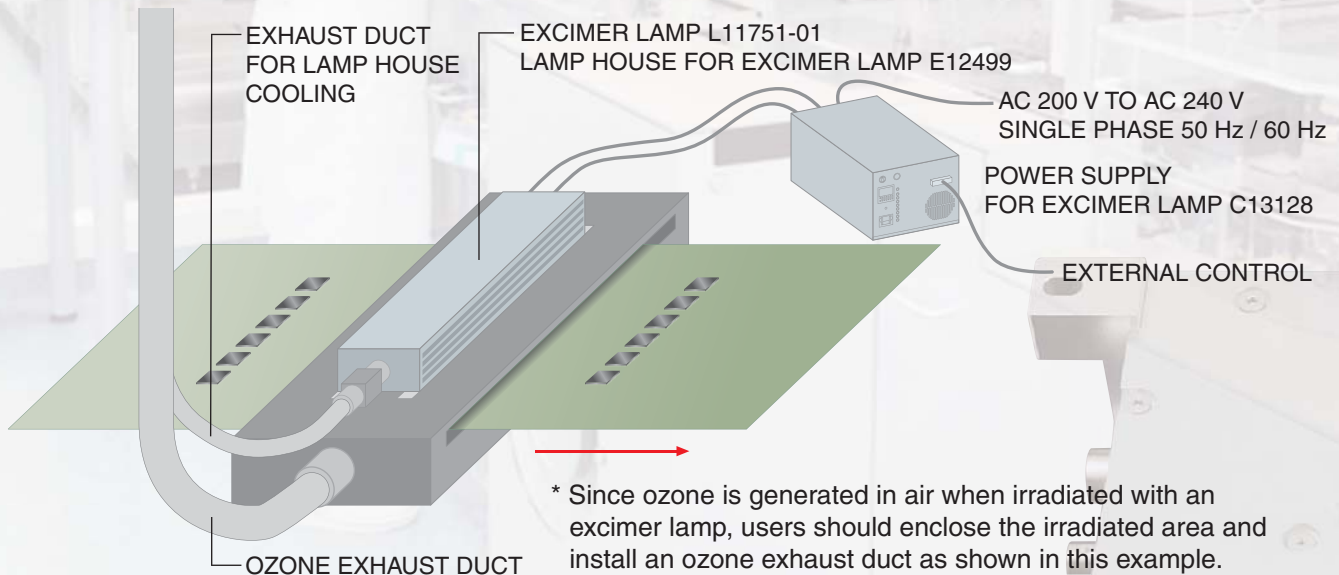

SPECIFICATIONS

EXCIMER LAMP L11751-01

Parameter	Description / Value
Rating	180 W
Emission wavelength	172 nm
Irradiance ①	Typ. 65 mW/cm ²
Lamp design life	2000 h
Operating / storage temperature range	+5 °C to +35 °C / -25 °C to +55 °C
Operating / storage humidity range	30 % to 80 % / below 80 % (no condensation)
Weight	220 g

① Value calculated on the assumption that the irradiance is measured with a Hamamatsu UV power meter C9536/H9535-172 placed in the immediate vicinity of the lamp.

LAMP HOUSE FOR EXCIMER LAMP E12499

Parameter	Description / Value
Irradiation area (W × H)	400 mm × 38 mm
Cooling method	Forced-air cooling by duct
Duct suction air flow rate ②	0.35 m ³ /min ± 0.08 m ³ /min
Operating / storage temperature range	+5 °C to +35 °C / -25 °C to +55 °C
Operating / storage humidity range	30 % to 80 % / below 80 % (no condensation)
Weight	10.3 kg

② Air flow rate in exhaust duct for lamp cooling

POWER SUPPLY FOR EXCIMER LAMP C13128

Parameter	Description / Value
Input voltage (AC)	200 V to 240 V, single phase 50 Hz / 60 Hz
Oscillation frequency	Approx. 2 MHz
RF output power	180 W
Power consumption	Typ. 320 VA Max. 600 VA
Operating / storage temperature range	+5 °C to +35 °C / -25 °C to +55 °C
Operating / storage humidity range	10 % to 80 % / below 80 % (no condensation)
Control method	Panel control / external control
Weight	12.4 kg

Parameter	Description / Value	
Applicable standards	EMC standard	IEC61326-1: 2013 Group 2 Class A
	Safety standards	IEC61010-1: 2010
	Environmental standards	IEC62471: 2008 Risk Group 2
		RoHS directive WEEE directive

CONTROL ITEMS

[Panel control]

- Lamp ON / OFF
- Total lamp ON time display and reset
- Irradiation signal
- Various error signals, life warning signal
- Internal control / external control switching

[External control]

- Lamp ON / OFF
- Total lamp ON time display and reset
- Irradiation signal
- Various error signals, life warning signal
- Interlock

DIMENSIONAL OUTLINE (Unit: mm)

● LAMP HOUSE FOR EXCIMER LAMP E12499

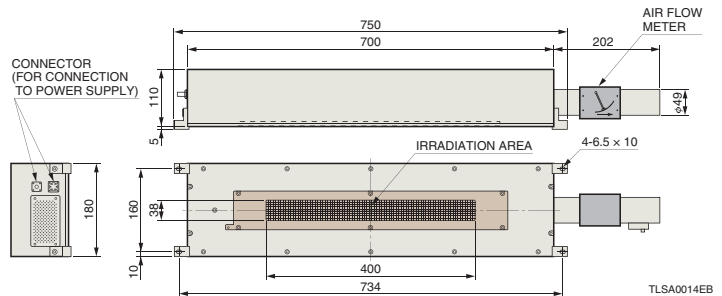

TLSA0014EB

● POWER SUPPLY FOR EXCIMER LAMP C13128

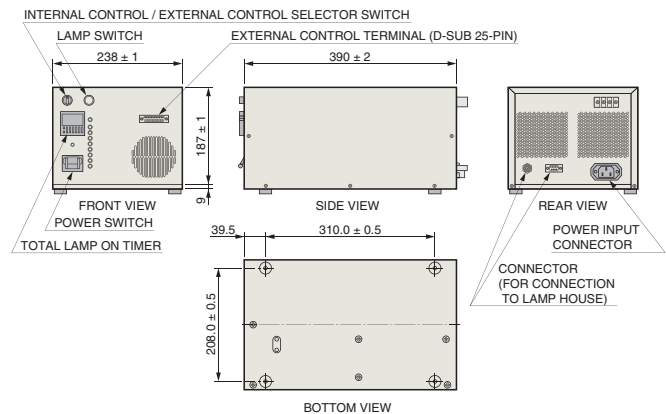

TLSA0015EB

Accessories

- Lamp house cable (5 m)
- Output cable (5 m)
- Power cable (5 m)
- External control connector (D-sub 25-pin)

FLAT EXCIMER™ EX-86U

L13129



Needs no extra space, no hassle for installation,
and easy to set up in production line

The “all-in-one” design with an internal power supply achieved a compact, lightweight body that can easily be set up in production sites by eliminating installation hassles with no need to choose installation space. High versatility for in-line usage makes it simple to incorporate the EX-86U into already existing lines and relocate production lines, etc.



INSTALLATION EXAMPLE

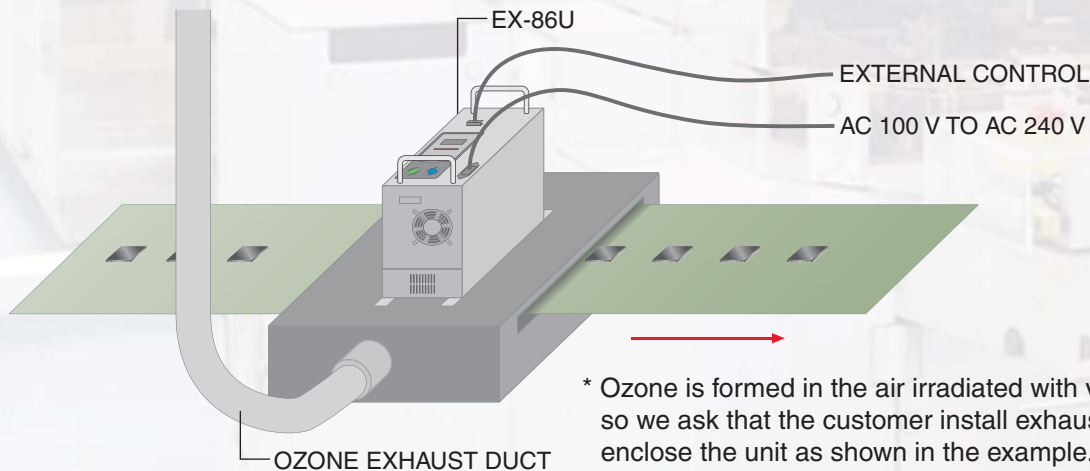

- * Ozone is formed in the air irradiated with vacuum UV light, so we ask that the customer install exhaust air ducts that enclose the unit as shown in the example.
- * The E12685 ozone decomposition unit (option) requiring no exhaust air duct can be used under certain conditions depending on the installation environment and conditions.

FEATURES

- Compact and lightweight
- All-in-one design with built-in power supply
- Operates on AC100 V to AC240 V

TYPE NO. GUIDE

L13129-C□

Number in □ indicates power cable specifications

1: For Japan 2: For North America 3: For EU 4: For China
5: For UK 7: For Thailand

SPECIFICATIONS

Parameter	Description / Value		
Emission wavelength	172 nm		
Irradiance ①	Typ. 65 mW/cm ²		
Irradiation area size (W×H)	86 mm × 40 mm		
Lamp design life ②	2000 h		
Input voltage (AC)	100 V to 240 V		
Power consumption	150 VA or less		
Cooling method	Forced air cooling by fan		
Operating / storage temperature range	+5 °C to +35 °C / -25 °C to +55 °C		
Operating / storage humidity range	10 % to 80 % / below 80 % (no condensation)		
Control method	Panel control / external control		
Weight	4.8 kg		
Applicable standards	EMC standard	IEC61326-1: 2013 Group 2 Class A	
	Safety standards	IEC61010-1: 2010	
	Environmental standards		IEC62471: 2008 Risk Group 2
			RoHS directive
		WEEE directive	

① Value calculated on the assumption that the irradiance is measured with a Hamamatsu UV power meter C9536/H9535-172 placed in the immediate vicinity of the lamp.

② When replacing the lamp, please specify the lamp type No. L12681.

CONTROL ITEMS

[Panel control]

- Manual irradiation / auto irradiation switching
- Lamp ON / OFF
- Total lamp ON time display and reset
- Irradiation time duration setting
- Setting irradiation time display
- Irradiation signal
- Various error signals, life warning signal

[External control]

- Manual irradiation / auto irradiation switching
- Lamp ON / OFF
- Irradiation signal
- Various error signals

DIMENSIONAL OUTLINE (Unit: mm)

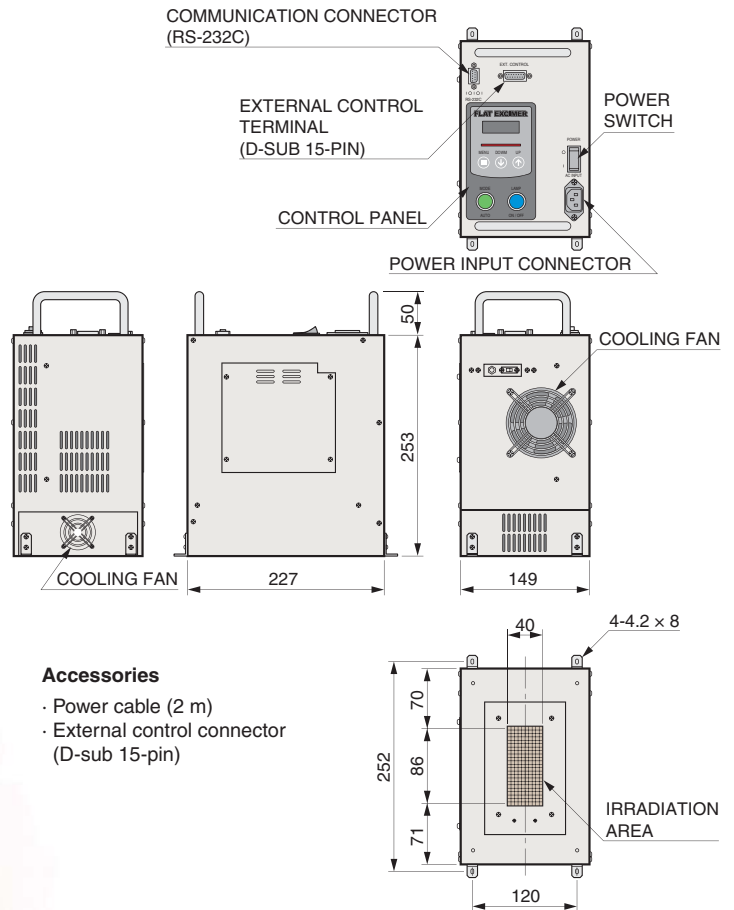

Accessories

- Power cable (2 m)
- External control connector (D-sub 15-pin)

TLSZA0046EA



FLAT EXCIMER™

EX-mini

L12530-01

R&D

Compact

Astonishingly easy to use & handle-like nothing you have ever seen!

Extraordinary portability makes it possible to make simple yet high accuracy tests and evaluations nearly anywhere. The EX-mini designed for R&D work offers the same performance as the EX-400 & EX-86U excimer lamp sources made for in-line operation, so you can put evaluation results from the EX-mini to use right away for in-line operation tasks.



FEATURES

- **All-in-one light source built into the irradiation box**

Just this one unit lets you start right away without having to design an irradiation box.

- **Small enough to carry around with you**

Size and weight are small enough to allow carrying it around with you for field work, and there are no special restrictions on installation positions or work environments.

- **High safety design via interlocks and error signals, etc.**

- **Irradiation time can be set as needed**

The EX-mini allows easy and accurate tests and evaluations by setting the irradiation time you need.

- **Operates on AC100 V to AC240 V power source**

230

233

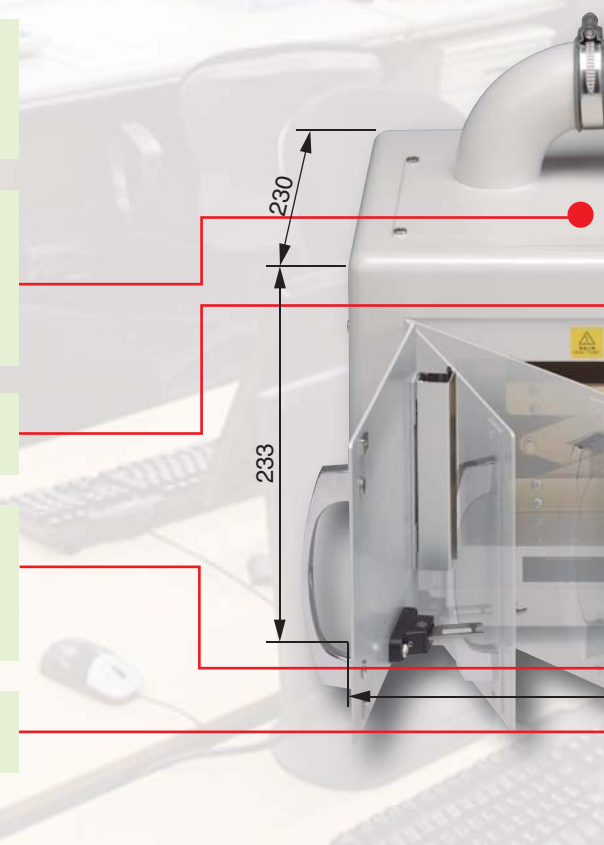

SPECIFICATIONS

Parameter		Description / Value
Emission wavelength		172 nm
Irradiance ①	Typ.	65 mW/cm ²
Irradiation area size (W×H)		86 mm × 40 mm
Lamp design life ②		2000 h
Input voltage (AC)		100 V to 240 V
Power consumption		150 VA or less
Cooling method		Forced air cooling by fan or duct
Duct suction air flow rate ③④		0.25 m ³ /min to 0.35 m ³ /min
Operating / storage temperature range		+5 °C to +35 °C / -25 °C to +55 °C
Operating / storage humidity range		10 % to 80 % / below 80 % (no condensation)
Control method		Panel control / external control
Weight		6.5 kg
Applicable standards	EMC standard	IEC61326-1: 2013 Group 2 Class A
	Safety standards	IEC61010-1: 2010
		IEC62471: 2008 Risk Group 2
	Environmental standards	RoHS directive WEEE directive

CONTROL ITEMS

[Panel control]

- Manual irradiation / auto irradiation switching
- Lamp ON / OFF
- Total lamp ON time display and reset
- Irradiation time duration setting
- Setting irradiation time display
- Irradiation signal
- Various error signals, life warning signal

[External control]

- Manual irradiation / auto irradiation switching
- Lamp ON / OFF
- Irradiation signal
- Various error signals

① Value calculated on the assumption that the irradiance is measured with a Hamamatsu UV power meter C9536/H9535-172 placed in the immediate vicinity of the lamp.

② When replacing the lamp, please specify the lamp type No. L12681-02.

③ Suction air flow rate of cooling and ozone exhaust air ducts.

④ Prepare exhaust duct or use our ozone decomposition unit E12685 (option) that does not exhaust duct.

DIMENSIONAL OUTLINE (Unit: mm)

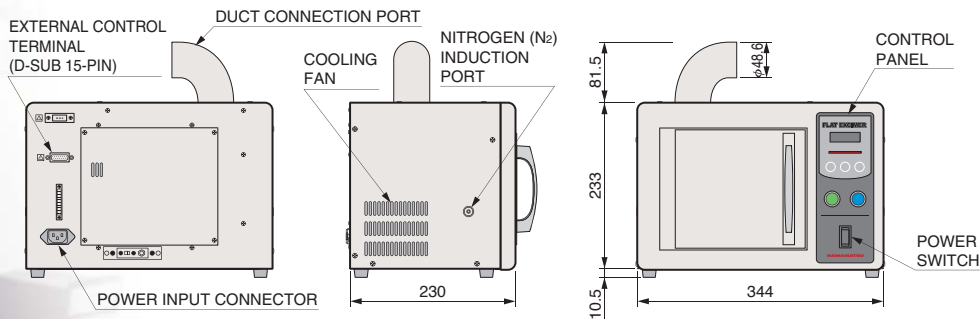

Accessories

- Power cable (2 m)
- External control connector (D-sub 15-pin)
- External fan shorting connector

TLSZA0036EA



OZONE DECOMPOSITION UNIT E12685

EXCIMER LAMP LIGHT SOURCE L12530-01

Inside dimensions (W × H × D): 204 mm × 118 mm × 139 mm (not including protrusions)

* Sample stage (jack, etc.) is not supplied with the EX-mini.

● Ozone decomposition unit E12685 (sold separately) for handy indoor exhaust (no exhaust ducts needed)

The EX-mini can be easily used anywhere since no exhaust duct installation is needed.

Just attach the connector to the EX-mini to start operation.

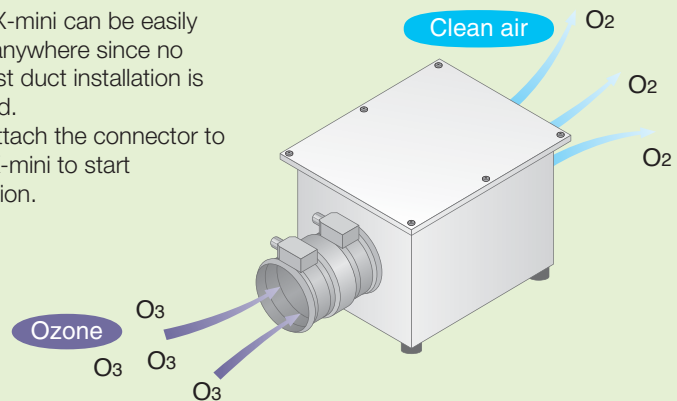

Outer dimensions (W × H × D): 136 mm × 109 mm × 115 mm (not including protrusions)
Weight: Approx. 1.2 kg

* Ozone decomposition unit only eliminates ozone.

Toxic substances might possibly be emitted depending on the material being irradiated, so install exhaust ducts in such cases.

* The internal ozone decomposition filter has a guaranteed service life of 2000 operating hours or within 1 year from the date of delivery, whichever comes first. Specify the A12686 as a replacement filter.

FLAT EXCIMER™

Q & A

Q1

What will I need to operate an excimer lamp light source besides the light source itself?

A

A power supply and exhaust air ducts are required. The excimer lamp light source is air-cooled so no cooling water or coolant is required.

EX-400	EX-86U	EX-mini
<ul style="list-style-type: none"> · AC 200 V to AC 240 V single phase · Exhaust duct for cooling lamp housing · Exhaust duct for evacuating ozone 	<ul style="list-style-type: none"> · AC 100 V to AC 240 V · Exhaust duct for evacuating ozone 	<ul style="list-style-type: none"> · AC 100 V to AC 240 V · Exhaust duct for evacuating ozone *

* No ozone exhaust duct is needed if using the E12685 ozone decomposition unit available as an option.

Q2

Is nitrogen (N₂) purge required on using an excimer lamp light source?

A

Our excimer lamp light source essentially does not require nitrogen (N₂) purges. However, if the irradiation distance is separated (about 5 mm or more as a rough guide), then nitrogen (N₂) purge will shorten the processing time.

Q3

Is it necessary to enclose the irradiated atmosphere? (Excimer lamp sources EX-400 and EX-86U)

A

As a countermeasure for leakage of UV rays and ozone exhaust, so the irradiated air must be enclosed. We recommend using SUS (stainless steel) or aluminum as the cover material for the irradiated air since this will not deteriorate or age so much and will not need replacement. If you need to view the interior of the irradiated air area, then install a window made of glass.

Q4

How high should the ozone exhaust level be? (Excimer lamp sources EX-400 and EX-86U)

A

A precise level cannot be strictly defined since the exhaust is affected by the volumetric size of the irradiated atmosphere and air tightness in the customer's manufacturing process. Please adjust the amount of exhaust air so that the irradiated atmosphere at the customer plant is a negative pressure (no ozone leakage occurs).

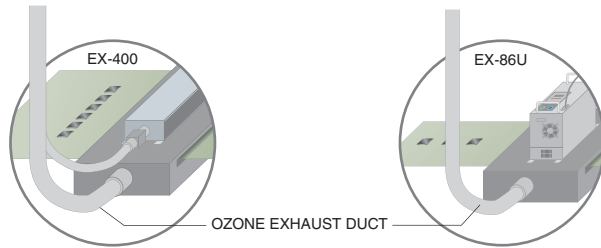

Q5

How high should the forced air cooling exhaust level be? (Excimer lamp source EX-400)

A

Provide exhaust at a duct suction air flow rate of 0.35 m³/min ± 0.08 m³/min. Adjust the air flow so that the air flow meter needle (supplied with the unit) is within the mark. (Also adjustable with the air flow meter since the air flow meter includes a damper.)

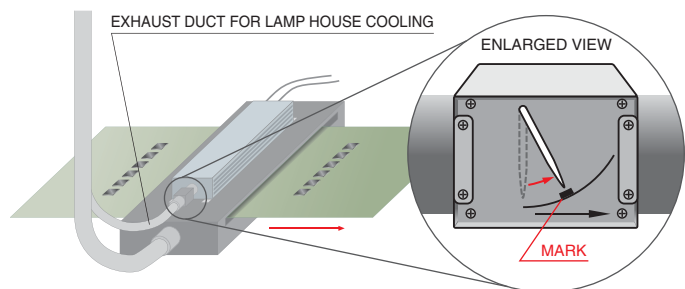

Q6

What precautions should I take when using an excimer lamp light source?

A

Place the target object for irradiation close to the excimer lamp source (We recommend a distance within 5 mm.). The farther the distance, the more the vacuum UV light is absorbed by oxygen, so the irradiation time takes longer until the desired effect is obtained.

Q7

Are there any limits on materials for surface modification or cleaning?

A

Surface modification gives a standard effect regardless of the material.
Cleaning can breakdown and eliminate organic matter but not inorganic matter.

Note: Irradiating vacuum UV light onto materials containing fluorine (fluororesin, gas containing fluorine) might exert harmful effects on the lamp due to decomposition products generated at that time, so do not irradiated vacuum UV light onto these materials.

Q8

How long does the processing effect from surface modification last?

A

This varies with the material. It usually tends to return to the original state over time after processing.

Q9

Are there thermal effects on the object irradiated with vacuum UV light?

A

There is almost no thermal effect on the irradiated object.

[Reference] When using the EX-400 excimer lamp source at a lamp-to-sample distance of 2 mm, the temperature of the sample will be 36 °C when irradiated for 1 minute and 58 °C when irradiated for 10 minutes (when the surface temperature of a polyethylene (PE) plate is measured with a thermocouple).

Q10

Any mandatory legal measures to observe when using excimer lamp sources?

A

These products must be used in compliance with regulations about radio frequency radiation.

Users of these products must be familiar with the applicable laws that regulate use of radiofrequency discharge devices. For more details, refer to international or domestic laws and regulations on radio frequency radiation and comply with the required procedures listed there.

RELATED PRODUCTS

● UV POWER METER C9536/H9535-172

This UV power meter directly detects UV light at the designated wavelengths without needing optical filters. It is ideal to monitor the absolute optical power (mW/cm²) as well as to control the accumulated UV energy. The sensor head can be detached from the controller and so can be mounted for measurements on a belt conveyor or in locations where routing cables is difficult.



PRODUCTION PROCESS SUPPORT PRODUCTS

● LINEAR IRRADIATION TYPE UV-LED UNIT LIGHTNINGCURE® LC-L5G

The LC-L5G is a linear irradiation type UV-LED light source that is ideal for drying UV coating, drying UV ink, and doing UV curing. The LC-L5G needs no chiller equipment or exhaust duct installation since it is air-cooled, small and lightweight while providing a high-output of 10 W/cm² at 385 nm. This will reduce the initial cost and save installation space.



● UV-LED SPOT LIGHT SOURCE LIGHTNINGCURE® LC-L1V3

The LC-L1V3 is a spot irradiation UV-LED light source ideal for UV curing. By slashing unneeded space to a minimum, we were able to build a small lightweight unit with 4-head drive that can fit into the palm of your hand.



GUIDE OF LOANER / DEMO UNITS

Hamamatsu provides loaner/demo units for use by customers, so if these are needed, contact us by phone or via our homepage. (Feel free to consult us for details on scheduling.)

APPLICATION TO USE HIGH-FREQUENCY EQUIPMENT

These products must be used in compliance with regulations about radio frequency radiation. Users of these products must be familiar with the applicable laws that regulate use of radio frequency discharge devices. For more details, refer to international or domestic laws and regulations on radio frequency radiation and comply with the required procedures listed there.

Subject to local technical requirements and regulations, availability of products included in this promotional material may vary. Please consult with our sales office. Information furnished by HAMAMATSU is believed to be reliable. However, no responsibility is assumed for possible inaccuracies or omissions. Specifications are subject to change without notice. No patent rights are granted to any of the circuits described herein. ©2017 Hamamatsu Photonics K.K.

HAMAMATSU PHOTONICS K.K. www.hamamatsu.com

HAMAMATSU PHOTONICS K.K., Electron Tube Division

314-5, Shimokanzo, Iwata City, Shizuoka Pref., 438-0193, Japan, Telephone: (81)539/62-5248, Fax: (81)539/62-2205

U.S.A.: Hamamatsu Corporation, 360 Foothill Road, Bridgewater, N.J. 08807-0910, U.S.A., Telephone: (1)908-231-0960, Fax: (1)908-231-1218 E-mail: usa@hamamatsu.com

Germany: Hamamatsu Photonics Deutschland GmbH, Arzbergerstr. 10, D-82211 Herrsching am Ammersee, Germany, Telephone: (49)8152-375-0, Fax: (49)8152-2658 E-mail: info@hamamatsu.de

France: Hamamatsu Photonics France S.A.R.L.: 19, Rue du Saule Trapu, Parc du Moulin de Massy, 91882 Massy Cedex, France, Telephone: (33)1 69 53 71 00, Fax: (33)1 69 53 71 10 E-mail: infos@hamamatsu.fr

United Kingdom: Hamamatsu Photonics UK Limited: 2 Howard Court, 10 Tewin Road, Welwyn Garden City, Hertfordshire AL7 1BW, United Kingdom, Telephone: (44)1707-294888, Fax: (44)1707-325777 E-mail: info@hamamatsu.co.uk

North Europe: Hamamatsu Photonics Norden AB: Torshamnsgatan 35 SE-164 40 Kista, Sweden, Telephone: (46)8-509-031-00, Fax: (46)8-509-031-01 E-mail: info@hamamatsu.se

Italy: Hamamatsu Photonics Italia S.r.l.: Strada della Moia, 1 int. 6, 20020 Arese (Milano), Italy, Telephone: (39)02-93581733, Fax: (39)02-93581741 E-mail: info@hamamatsu.it

China: Hamamatsu Photonics (China) Co., Ltd.: B1201 Jiaming Center, No.27 Dongsanhuan Bellu, Chaoyang District, Beijing 100020, China, Telephone: (86)10-6586-6006, Fax: (86)10-6586-2866 E-mail: hpc@hamamatsu.com.cn

Taiwan: Hamamatsu Photonics Taiwan Co., Ltd.: 8F-3, No.158, Section2, Gongdao 5th Road, East District, Hsinchu, 300, Taiwan R.O.C. Telephone: (886)03-659-0080, Fax: (886)07-611-7238 E-mail: info@tw.hpk.co.jp

TLSZ1027E03
APR. 2017 IP