

# Mini-spectrometers

[ **TM series** ]

C10082MD

C10083MD



**For UV to near IR, integrating optical system, image sensor and circuit**

TM series mini-spectrometers are polychromators integrated with optical elements, an image sensor and a driver circuit. Two models are available: C10082MD (TM-UV/VIS-MOS) and C10083MD (TM-VIS/NIR-MOS). Light to be measured is guided into the entrance port of TM series through an optical fiber and the spectrum measured with the built-in image sensor is output from the USB port to a PC for data acquisition. No external power supply is required since USB bus power is used for circuit operation.

Mini-spectrometer TM series comes supplied with free evaluation software that allows setting measurement conditions, acquiring and saving data, and displaying graphs. Original measurement software can be designed on an end-user's side as DLL's function specification is disclosed.

## Features

- High throughput due to transmission grating made of quartz
- Highly accurate optical characteristics
- No external power supply required: uses USB bus power
- Wide spectral response range
- Easy to install into equipment
- Wavelength conversion factor\*1 is recorded in internal memory.
- Supports external trigger input\*2

\*1: A conversion factor for converting the image sensor pixel number into a wavelength is recorded in the module. A calculation factor for converting the A/D converted count into the input light intensity is not provided.

\*2: Coaxial cable for external trigger input sold separately. Refer to the "Mini-spectrometers Selection Guide" for details on external triggers.

## Applications

- Light source spectrum measurement
- Sunlight or illumination analysis
- Absorbance measurement

## Optical characteristics

Parameter	TM-UV/VIS-MOS	TM-VIS/NIR-MOS	Unit
	C10082MD	C10083MD	
Spectral response range	200 to 800	320 to 1000	nm
Spectral resolution (Spectral response half width)*3	6 max.	8 max.	nm
Wavelength reproducibility*4	-0.2 to +0.2		nm
Wavelength temperature dependence	-0.4 to +0.4		nm/°C
Spectral stray light*3 *5	-35 max.	-33 max.	dB

\*3: Depends on the slit opening. Values were measured with the slit listed in the table "Structure".

\*4: Measured under constant light input conditions

\*5: When monochromatic light of the following wavelengths is input, spectral stray light is defined as the ratio of the count measured at the input wavelength, to the count measured in a region of the input wavelength  $\pm 40$  nm.  
C10082MD: 500 nm, C10083MD: 650 nm

## Electrical characteristics

Parameter	Specification	Unit
A/D conversion	16	bit
Integration time	5 to 10000	ms
Interface	USB 1.1	-
USB bus power current consumption	100 max.	mA

## Structure

Parameter	Specification	Unit
Dimensions (W × D × H)	94 × 90 × 55	mm
Weight	470	g
Image sensor	CMOS linear image sensor (S8378-1024Q)	-
Number of pixels	1024	pixels
Slit* <sup>6</sup> (H × V)	70 × 800	μm
NA* <sup>7</sup>	0.22	-
Connector for optical fiber	SMA905D	-

\*6: Entrance slit aperture size

\*7: Numerical aperture (solid angle)

## Absolute maximum ratings

Parameter	Value	Unit
Operating temperature* <sup>8</sup>	+5 to +40	°C
Storage temperature* <sup>8</sup>	-20 to +70	°C

\*8: No dew condensation

When there is a temperature difference between a product and the surrounding area in high humidity environment, dew condensation may occur on the product surface. Dew condensation on the product may cause deterioration in characteristics and reliability.

Note: Exceeding the absolute maximum ratings even momentarily may cause a drop in product quality. Always be sure to use the product within the absolute maximum ratings.

## Spectral response

C10082MD

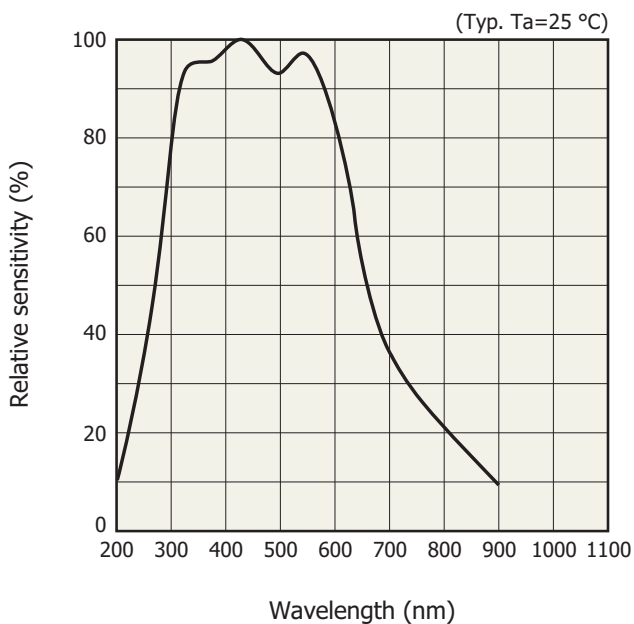

KACCB0417EB

C10083MD

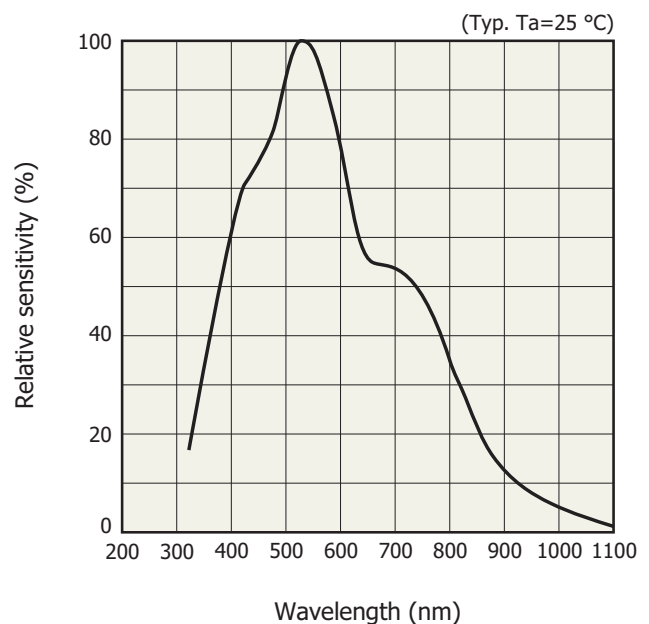

KACCB0421EB

**Spectral resolution vs. wavelength (typical example)**

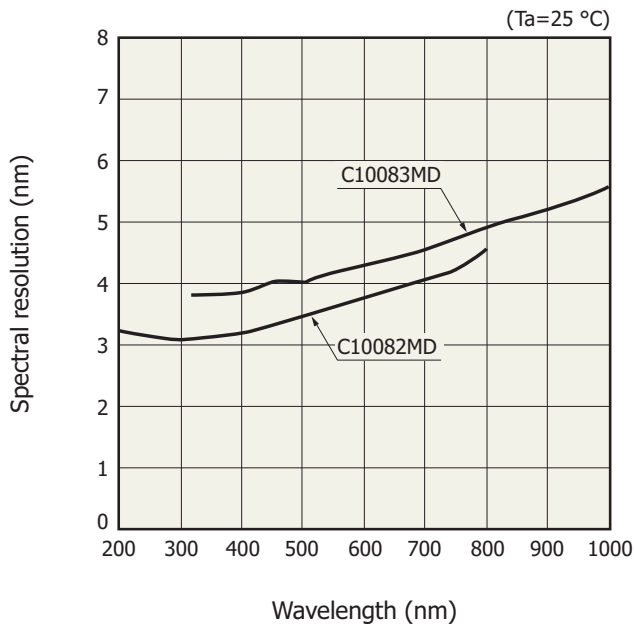

KACCB0265EA

**Linearity (typical example)**

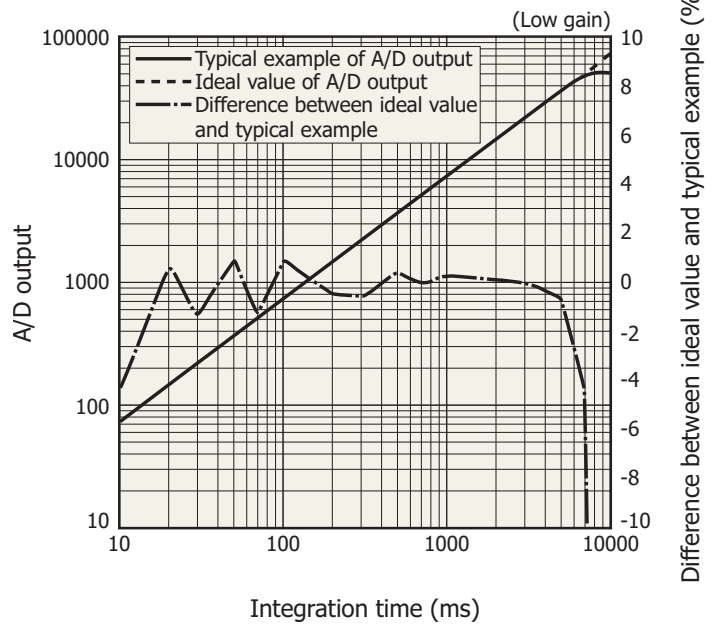

KACCB0244EA

A/D output is the output with dark output is subtracted when light is input. The difference between the ideal value and typical example contains a measurement error. The smaller the A/D output, the larger the measurement error.

**Dark output vs. ambient temperature (typical example)**

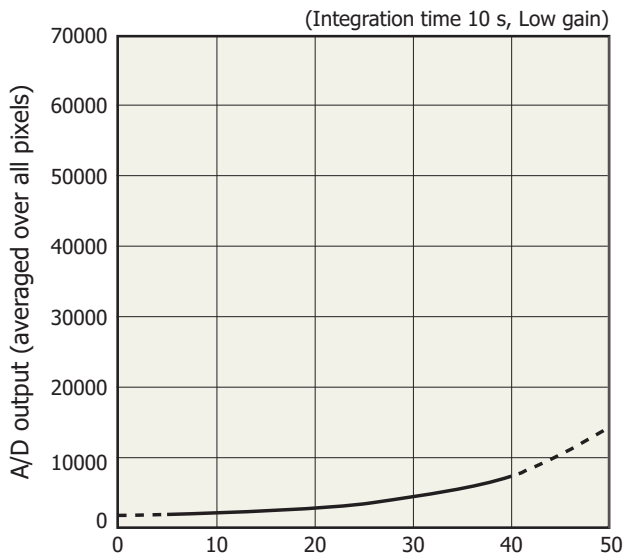

KACCB0245EA

A/D output is the sum of the sensor and circuit offset outputs and the sensor dark output.

**Optical component layout**

TM series mini-spectrometers use a transmission holographic grating made of quartz and precision optical components arranged on a rugged optical base, making it possible to deliver high throughput and highly accurate optical characteristics.

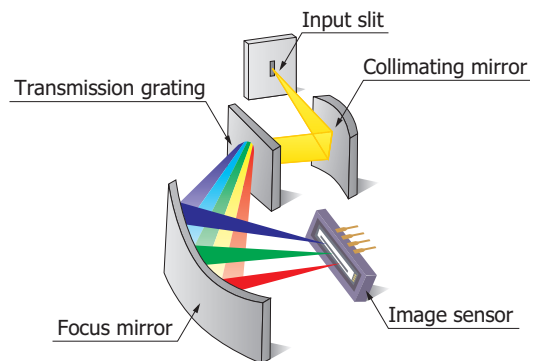

KACCC0287EA

### ❏ Connection example (transmission light measurement)

Light to be measured is guided into the entrance port of TM series through an optical fiber and the spectrum measured with the built-in image sensor is output through the USB port to a PC for data acquisition. There are no moving parts inside the unit so stable measurements are obtained at all times. An optical fiber that guides light input from external sources allows a flexible measurement setup.

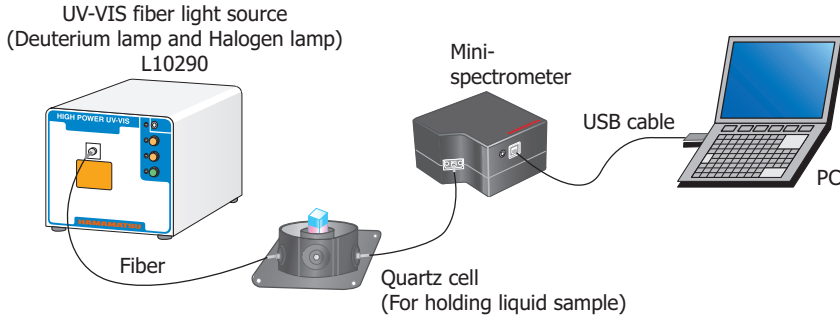

KACCC028REF

### ❏ Evaluation software package (supplied with unit)

Installing the evaluation software package (Spec Evaluation. exe)<sup>\*9</sup> into your PC allows running the following basic tasks:

- Measurement data acquisition and save
- Measurement condition setup
- Module information acquisition  
(wavelength conversion factor, polychromator type, etc.)
- Graphic display
- Arithmetic operation
  - Pixel number to wavelength conversion
  - Comparison calculation with reference data (transmittance, reflectance)
  - Dark subtraction
  - Gaussian approximation (peak position and count, FWHM)

Note:

- Two or more mini-spectrometers can be connected and used with one PC simultaneously.
- The external trigger input function works with DLL, but does not function on the supplied evaluation software. If using an external trigger input, the user software must be configured to support that function.

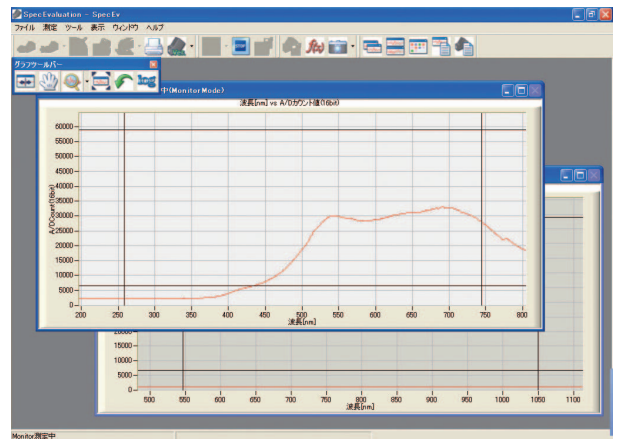

\*9: Compatible OS: Microsoft® Windows® 7 Professional SP1 (32-bit, 64-bit)  
Microsoft Windows 8 Professional (32-bit, 64-bit)  
Microsoft Windows 10 Professional (32-bit, 64-bit)

DLL for controlling hardware is also provided.

You can develop your own measurement programs by using a following software development environment.

Microsoft Visual Studio® 2008 (SP1) Visual C++®

Microsoft Visual Studio 2008 (SP1) Visual Basic®

Note: Microsoft, Windows, Visual Studio, Visual C++ and Visual Basic are either registered trademarks or trademarks of Microsoft Corporation in the United States and other countries.

Measurement example (C10082MA)

Line spectra from visible LED

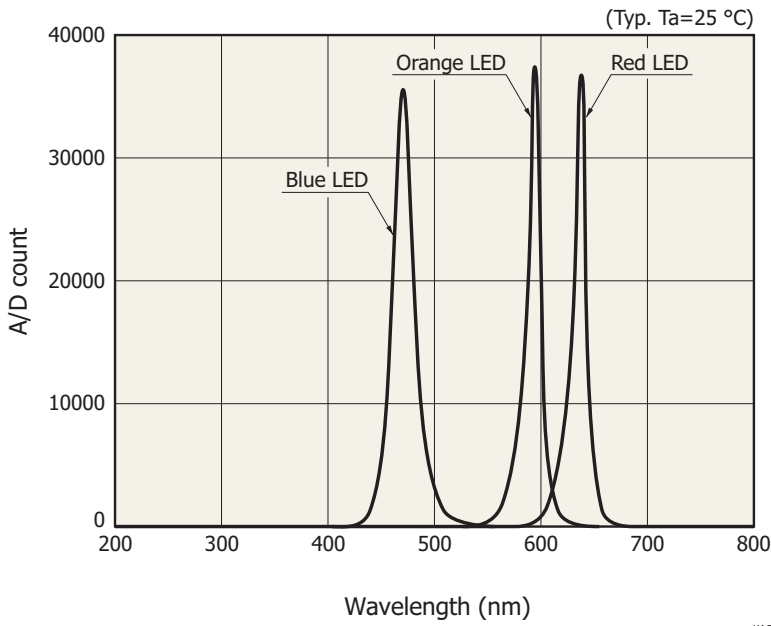

KACCB0126EB

Dimensional outline (unit: mm)

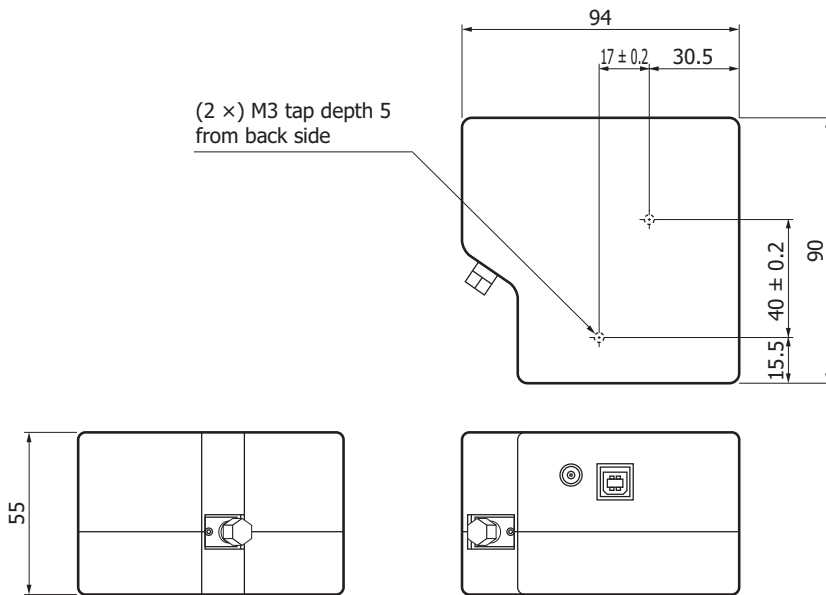

Tolerance unless otherwise noted:  $\pm 0.5$   
 Weight: 470 g

KACCA0171EE

### Accessories

- USB cable
- Dedicated software (evaluation software, sample software, DLL)

### Options (sold separately)

- Optical fiber for light input

Type no.	Product name	Core diameter ( $\mu\text{m}$ )	Specification
A15362-01	Fiber for UV/visible range (resistance to UV)	600	NA=0.22, length 1.5 m, connectorized SMA905D at both ends

- Coaxial cable for external trigger input A10670

Dimensional outline (unit: mm)

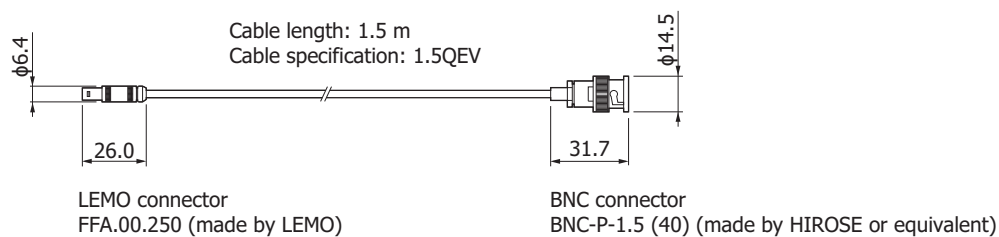

KACCA0220EB

## Related information

[http://www.hamamatsu.com/sp/ssd/doc\\_en.html](http://www.hamamatsu.com/sp/ssd/doc_en.html)

### ■ Precautions

- Disclaimer
- Mini-spectrometers

### ■ Technical information

- Mini-spectrometers

Information described in this material is current as of June 2019.

Product specifications are subject to change without prior notice due to improvements or other reasons. This document has been carefully prepared and the information contained is believed to be accurate. In rare cases, however, there may be inaccuracies such as text errors. Before using these products, always contact us for the delivery specification sheet to check the latest specifications.

The product warranty is valid for one year after delivery and is limited to product repair or replacement for defects discovered and reported to us within that one year period. However, even if within the warranty period we accept absolutely no liability for any loss caused by natural disasters or improper product use. Copying or reprinting the contents described in this material in whole or in part is prohibited without our prior permission.

# HAMAMATSU

[www.hamamatsu.com](http://www.hamamatsu.com)

HAMAMATSU PHOTONICS K.K., Solid State Division

1126-1 Ichino-cho, Higashi-ku, Hamamatsu City, 435-8558 Japan, Telephone: (81)53-434-3311, Fax: (81)53-434-5184

U.S.A.: Hamamatsu Corporation: 360 Foothill Road, Bridgewater, N.J. 08807, U.S.A., Telephone: (1)908-231-0960, Fax: (1)908-231-1218, E-mail: [usa@hamamatsu.com](mailto:usa@hamamatsu.com)

Germany: Hamamatsu Photonics Deutschland GmbH: Arzbergerstr. 10, D-82211 Herrsching am Ammersee, Germany, Telephone: (49)8152-375-0, Fax: (49)8152-265-8, E-mail: [info@hamamatsu.de](mailto:info@hamamatsu.de)

France: Hamamatsu Photonics France S.A.R.L.: 19, Rue du Saule Trapu, Parc du Moulin de Massy, 91882 Massy Cedex, France, Telephone: (33)1 69 53 71 00, Fax: (33)1 69 53 71 10, E-mail: [infos@hamamatsu.fr](mailto:infos@hamamatsu.fr)

United Kingdom: Hamamatsu Photonics UK Limited: 2 Howard Court, 10 Tewin Road, Welwyn Garden City, Hertfordshire AL7 1BW, United Kingdom, Telephone: (44)1707-294888, Fax: (44)1707-325777, E-mail: [info@hamamatsu.co.uk](mailto:info@hamamatsu.co.uk)

North Europe: Hamamatsu Photonics Norden AB: Torshamnsgatan 35 16440 Kista, Sweden, Telephone: (46)8-509 031 00, Fax: (46)8-509 031 01, E-mail: [info@hamamatsu.se](mailto:info@hamamatsu.se)

Italy: Hamamatsu Photonics Italia S.r.l.: Strada della Moia, 1 int. 6, 20020 Arese (Milano), Italy, Telephone: (39)02-93 58 17 33, Fax: (39)02-93 58 17 41, E-mail: [info@hamamatsu.it](mailto:info@hamamatsu.it)

China: Hamamatsu Photonics (China) Co., Ltd.: B1201, Jiaming Center, No.27 Dongsanhuan Beilu, Chaoyang District, 100020 Beijing, P.R.China, Telephone: (86)10-6586-6006, Fax: (86)10-6586-2866, E-mail: [hpc@hamamatsu.com.cn](mailto:hpc@hamamatsu.com.cn)

Taiwan: Hamamatsu Photonics Taiwan Co., Ltd.: 8F-3, No. 158, Section2, Gongdao 5th Road, East District, Hsinchu, 300, Taiwan R.O.C. Telephone: (886)3-659-0080, Fax: (886)3-659-0081, E-mail: [info@hamamatsu.com.tw](mailto:info@hamamatsu.com.tw)