

S11059-02DT/-03DS

## I<sup>2</sup>C interface-compatible color sensor

The S11059-02DT/-03DS is a digital color sensor that supports the I<sup>2</sup>C (inter-integrated circuit) interface. It is sensitive to red ( $\lambda=615$  nm), green ( $\lambda=530$  nm), blue ( $\lambda=460$  nm), and infrared ( $\lambda=855$  nm) light, and outputs detected results as 16-bit digital data for each color. The photodiode for each color is automatically switched sequentially to perform measurements. The sensitivity and integration time can be adjusted so that light measurements can be performed over a wide range.

### Features

- I<sup>2</sup>C interface compatible
- Sequential measurements of red, green, blue, and infrared light
- 2-step sensitivity switching (sensitivity ratio 1 : 10)
- Sensitivity adjustment by setting the integration time
- Low voltage (2.5 V or 3.3 V) operation
- Low current consumption: 75  $\mu$ A typ.
- With internal infrared-cut filter
- Wide dynamic range (Low gain: 1 to 10 k $\times$ )
- Standard packing state  
S11059-02DT: reel  
S11059-03DS: stick

### Applications

- LCD backlight adjustment for cell phones, notebook PC, etc.
- Energy-saving sensor for large-size TV, etc.
- Various types of light detection or color adjustment

### Absolute maximum ratings

Parameter	Symbol	Condition	Value	Unit
Supply voltage	Vdd	Ta=25 °C	-0.3 to +6	V
Output current	Io	Ta=25 °C	$\pm$ 10	mA
Power dissipation	P	Ta=25 °C	300	mW
Operating temperature	Topr	No dew condensation*1	-25 to +80	°C
Storage temperature	Tstg	No dew condensation*1	-40 to +85	°C
Reflow soldering conditions*2	Tsol		Peak temperature 240 °C max., 1 time (see page 10)	-

\*1: When there is a temperature difference between a product and the surrounding area in high humidity environment, dew condensation may occur on the product surface. Dew condensation on the product may cause deterioration in characteristics and reliability.

\*2: Moisture absorption and reflow conditions: JEDEC J-STD-020D LEVEL5a

Note: Exceeding the absolute maximum ratings even momentarily may cause a drop in product quality. Always be sure to use the product within the absolute maximum ratings.

### Recommended operating conditions

Parameter	Symbol	Condition	Min.	Typ.	Max.	Unit
Supply voltage	Vdd		2.25	-	3.63	V
High level input voltage (SDA, SCL)*3	Vih		0.7Vdd	-	Vdd + 0.5	V
Low level input voltage (SDA, SCL)*3	Vil		-0.5	-	0.2Vdd	V
Bus capacitance (SDA, SCL)	Cbus		-	-	400	pF

\*3: Set so that Vdd=Vbus. Normal operation cannot be guaranteed unless used with this condition.

## Electrical and optical characteristics

■ Sensor section [Ta=25 °C, Vdd=Vbus=3.3 V, A light source, unless otherwise noted (initial setting: low gain, integration time: 546 ms/ch)]\*4

Parameter		Symbol	Condition	Min.	Typ.	Max.	Unit	
Spectral response range*5		$\lambda$	Blue		400 to 540		nm	
			Green		455 to 630			
			Red		575 to 660			
			Infrared, more than 700 nm		785 to 885			
Peak sensitivity wavelength		$\lambda_p$	Blue	-	460	-	nm	
			Green	-	530	-		
			Red	-	615	-		
			Infrared, more than 700 nm	-	855	-		
Current consumption	Operating mode	I <sub>dd</sub>	E=0 lx (dark state), excluding output current	30	75	150	$\mu$ A	
	Standby mode	I <sub>dds</sub>		0.1	1.0	3.0		
Dark count		S <sub>d</sub>	E=0 lx (dark state)	-	-	5	counts	
Gain ratio		rg	High gain/Low gain	-	10	-	-	
Photosensitivity	Low gain	S <sub>bl</sub>	Blue	Initial setting	2.4	4.4	6.4	counts/lx
			Green		4.6	8.3	12.0	
			Red		6.2	11.2	16.3	
			Infrared		-	3.0	-	
		S <sub>bl</sub>	Blue	Initial setting*6	3.3	4.4	5.5	
			Green		6.2	8.3	10.4	
			Red		8.4	11.2	14.0	
			Infrared		-	3.0	-	
Red/Blue sensi. ratio	Low gain	S <sub>rl</sub> /S <sub>bl</sub>	Initial setting	1.9	2.6	3.2	-	
Red/Green sensi. ratio		S <sub>rl</sub> /S <sub>gl</sub>	Same chip	1.0	1.4	1.7		
Blue/Green sensi. ratio		S <sub>bl</sub> /S <sub>gl</sub>		0.4	0.6	0.7		
Photosensitivity	High gain	S <sub>bh</sub>	Blue	Integration time 546 ms/ch	24.0	44.8	65.5	counts/lx
			Green		46.5	85.0	123.5	
			Red		64.0	117.0	170.0	
			Infrared		-	30.0	-	
		S <sub>bh</sub>	Blue	Integration time 546 ms/ch*6	33.5	45.0	56.5	
			Green		63.5	85.0	106.5	
			Red		88.0	117.0	146.5	
			Infrared		-	30.0	-	
Red/Blue sensi. ratio	High gain	S <sub>rh</sub> /S <sub>bh</sub>	Integration time 546 ms/ch	1.9	2.6	3.3	-	
Red/Green sensi. ratio		S <sub>rh</sub> /S <sub>gh</sub>	Same chip	1.0	1.4	1.8		
Blue/Green sensi. ratio		S <sub>bh</sub> /S <sub>gh</sub>		0.4	0.6	0.7		

\*4: Provide light shielding so that no light enters from anywhere other than the top surface of the filter.

\*5: Relative sensitivity=more than 10%

\*6: Integration time is measured and corrected. See "Compensation method for sensitivity variation". Integration time measurement accuracy is 0.36%.

■ I<sup>2</sup>C section (Ta=25 °C, Vdd=3.3 V, unless otherwise noted)

Parameter		Symbol	Condition	Min.	Typ.	Max.	Unit
I <sup>2</sup> C address		ADDR	7 bits		0x2A (0101010)		-
I <sup>2</sup> C clock frequency		fclk		1	-	400	kHz
SDA, SCL output voltage	High level	V <sub>oh</sub>	R <sub>p</sub> =2.2 k $\Omega$	0.7 V <sub>bus</sub>	-	-	V
	Low level	V <sub>ol</sub>	R <sub>p</sub> =2.2 k $\Omega$	0	-	0.4	V
Input/output terminal capacitance		C <sub>i</sub>		-	-	20	pF
SDA/SCL output fall time*7		t <sub>f</sub>	R <sub>p</sub> =2.2 k $\Omega$ , C <sub>p</sub> =400 pF	-	-	250	ns

\*7: SCL/SDA output rise time is determined by a time constant of C<sub>bus</sub> × R<sub>p</sub>.

Note: The I<sup>2</sup>C interface (SDA, SCL) timings conform to the "I<sup>2</sup>C bus specification version 2.1".

## Register map

Adrs	Function	bit								
		7	6	5	4	3	2	1	0	
00	Control	ADC reset 1: Reset 0: Operation	Standby function 1: Standby mode 0: Operating mode	Standby function monitor	-	Gain selection 1: High gain 0: Low gain	Integration mode 1: Manual setting mode 0: Fixed period mode	Integration time setting (00) 87.5 $\mu$ s, (01) 1.4 ms (10) 22.4 ms, (11) 179.2 ms		
01	Manual timing register	Integration time manual setting register (MSB)								
02		Integration time manual setting register (LSB)								
03	Sensor data register (red)	Output data (red, MSB)								
04		Output data (red, LSB)								
05	Sensor data register (green)	Output data (green, MSB)								
06		Output data (green, LSB)								
07	Sensor data register (blue)	Output data (blue, MSB)								
08		Output data (blue, LSB)								
09	Sensor data register (infrared)	Output data (infrared, MSB)								
0A		Output data (infrared, LSB)								

Adrs 00 bit 7: Asserting this bit to "1", the ADC block is reset. The register data is not reset. To start the operation, set this bit to "0".

Adrs 00 bit 6: Asserting this bit to "1" the device goes into standby mode. The ADC block stops its operation. The register data is not reset. To start the operation, set this bit to "0".

Adrs 00 bit 5: This monitors auto standby function. "1" means standby mode. This is read only.

Adrs 00 bit 3: Gain selection bit. "1" is high gain mode and "0" is low gain mode. This bit is selecting the photodiode area. The size ratio of high gain photodiode area and low gain photodiode area is 10 : 1. Therefore the gain ratio is 10 times from low to high.

Adrs 00 bit 2: Asserting this bit to "1", the device goes into manual setting mode. Deasserting this bit to 0, goes into fixed period mode. In manual setting mode, the S11059-02DT automatically goes to standby mode after a measurement is made. In fixed period mode, measurements are continuously repeated.

Adrs 00 bit 1,0: These bits select the period of internal basis clock. The period is equal to integration time per color in fixed period mode. "00" is 87.5  $\mu$ s, "01" is 1.4 ms, "10" is 22.4 ms, "11" is 179.2 ms. In manual setting mode, "00" is 175  $\mu$ s, "01" is 2.8 ms, "10" is 44.8 ms, "11" is 368 ms. The integration time per color is set to multiple value (Adrs 01 & 02) with the period.

Adrs 01 & 02: This is a multiple value setting in manual setting mode, and can be set to a minimum of 0x0000 and a maximum of 0xFFFF (65535). This is used to set how far to expand the integration time per color which specified by "Integration time setting" (Tint). For example, if you want to set the integration time per color to 546 ms, set 175  $\mu$ s by Tint="00" and then set this register to N=3120 (0xC30).

Mode	Manual timing register (Adrs 01 & 02)	Integration time setting (Tint)			
		00	01	10	11
Fixed period mode	Disabled	87.5 $\mu$ s	1.4 ms	22.4 ms	179.2 ms
Manual setting mode	N	175 $\times$ N $\mu$ s	2.8 $\times$ N ms	44.8 $\times$ N ms	358.4 $\times$ N ms

Adrs 03 to 0A: These bytes are register for sensor data. S11059-02DT measurement result is stored in these registers when the I<sup>2</sup>C command is changed to read mode. The values are kept until the next measurement cycle.

## Initial setting [Low gain, manual setting mode, Tint=00 (175 $\mu$ s), integration time 546 ms/ch]

Adrs	Function	bit								Hex
		7	6	5	4	3	2	1	0	
00	Control	1	1	1	-	0	1	0	0	0xE4
01	Manual timing register	0	0	0	0	1	1	0	0	0x0C
02		0	0	1	1	0	0	0	0	0x30

**Program example**

Condition 1: Initial setting [manual setting mode, low gain, Tint=00 (175 μs), integration time 546 ms/ch (0x0C30 is set in manual timing register)]

■ Command

Action		Data body								Ack	Remark
Address call (0x2A)	S	0	1	0	1	0	1	0	W	A	7-bit address
Register call (0x00)		0	0	0	0	0	0	0	0	A	Calls control byte
Register write (0x84)		1	0	0	0	0	1	0	0	A	ADC reset, standby disabled
Address call (0x2A)	Sr	0	1	0	1	0	1	0	W	A	Restart, address
Register call (0x00)		0	0	0	0	0	0	0	0	A	Calls control byte
Register write (0x04)		0	0	0	0	0	1	0	0	A	P ADC reset disabled, bus release
Wait longer than integration time (>2184 ms)											
Address call (0x2A)	S	0	1	0	1	0	1	0	W	A	7-bit address
Register call (0x03)		0	0	0	0	0	0	1	1	A	Calls output data byte
Address call (0x2A)	Sr	0	1	0	1	0	1	0	R	A	Changes to read mode
Data read out (R: MSB)		X	X	X	X	X	X	X	X	A	Red data output
Data read out (R: LSB)		X	X	X	X	X	X	X	X	A	
Data read out (G: MSB)		X	X	X	X	X	X	X	X	A	Green data output
Data read out (G: LSB)		X	X	X	X	X	X	X	X	A	
Data read out (B: MSB)		X	X	X	X	X	X	X	X	A	Blue data output
Data read out (B: LSB)		X	X	X	X	X	X	X	X	A	
Data read out (Infrared: MSB)		X	X	X	X	X	X	X	X	A	Infrared data output
Data read out (Infrared: LSB)		X	X	X	X	X	X	X	X	$\bar{A}$ P	

S=Start condition, Sr=Restart condition, A=Acknowledge,  $\bar{A}$ =Acknowledge by host, P=Stop condition, R=Read mode (1), W=Write mode (0),  $\bar{A}$ =not acknowledge

■ Format

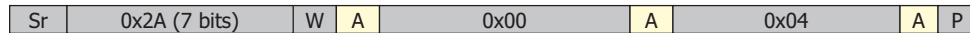

Wait

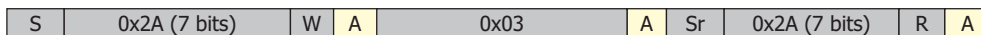

from master to slave      from slave to master

KPIC00334EA

Condition 2 [fixed period mode, high gain, Tint=01 (1.4 ms), integration time 1.4 ms/ch]

■ Command

Action		Data body							Ack	Remark	
Address call (0x2A)	S	0	1	0	1	0	1	0	W	A	7-bit address
Register call (0x00)		0	0	0	0	0	0	0	0	A	Calls control byte
Register write (0x89)		1	0	0	0	1	0	0	1	A	ADC reset, standby disabled
Address call (0x2A)	Sr	0	1	0	1	0	1	0	W	A	7-bit address
Register call (0x00)		0	0	0	0	0	0	0	0	A	Calls control byte
Resistor write (0x09)		0	0	0	0	1	0	0	1	A	P   ADC reset disabled, bus release
Wait longer than integration time (> 5.6 ms). Within this period, repeat measurement is continued.											
Address call (0x2A)	S	0	1	0	1	0	1	0	W	A	7-bit address
Register call (0x03)		0	0	0	0	0	0	1	1	A	Calls output data byte
Address call (0x2A)	Sr	0	1	0	1	0	1	0	R	A	Changes to read mode
Data read out (R: MSB)		X	X	X	X	X	X	X	X	A	Red data output
Data read out (R: LSB)		X	X	X	X	X	X	X	X	A	
Data read out (G: MSB)		X	X	X	X	X	X	X	X	A	Green data output
Data read out (G: LSB)		X	X	X	X	X	X	X	X	A	
Data read out (B: MSB)		X	X	X	X	X	X	X	X	A	Blue data output
Data read out (B: LSB)		X	X	X	X	X	X	X	X	A	
Data read out (Infrared: MSB)		X	X	X	X	X	X	X	X	A	Infrared data output
Data read out (Infrared: LSB)		X	X	X	X	X	X	X	$\bar{A}$	P	

S=Start condition, Sr=Restart condition, A=Acknowledge, A=Acknowledge by host, P=Stop condition, R=Read mode(1), W=Write mode(0),  $\bar{A}$ =not acknowledge

■ Format

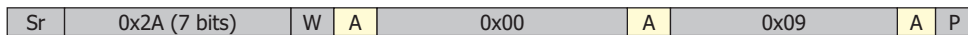
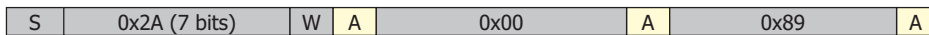

Wait

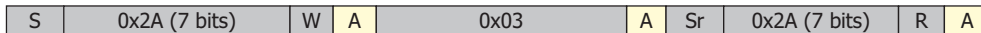

from master to slave      from slave to master

KPIC00335EA

**Compensation method for sensitivity variation**

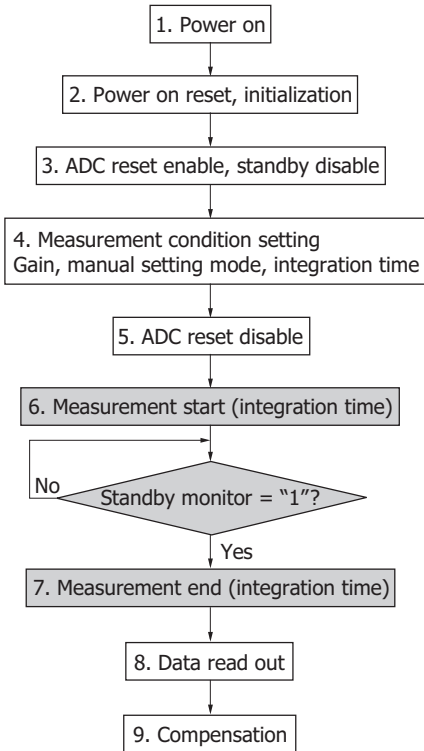

Sensitivity variation can be decreased using the compensation coefficient which is calculated from the integration time measurement result. Explanation of compensation method is shown as follows.

■ Integration time measurement method

In case of integration time measurement, it is necessary to set manual setting mode. The integration time measurement starts after "ADC reset" disabled. To measure the finishing integration time (measurement) T<sub>meas</sub>, check "Standby monitor" bit until it becomes to "1".

■ Compensation method

The sensitivity compensation that used integration time is as follows:

$$K = \frac{T_{set}}{T_{meas}}$$

$$S' = S \cdot K$$

- K : compensation coefficient
- T<sub>set</sub> : integration time (setting)
- T<sub>meas</sub>: integration time (measurement)
- S : photo sensitivity (measurement)
- S' : photo sensitivity (compensation)

■ Measurement accuracy of integration time

The measurement minimum resolution of T<sub>meas</sub> is defined by the looping duration (T<sub>unit</sub>). In case of default setting, the T<sub>set</sub> is 2184 ms and assuming the T<sub>unit</sub> to 7.8 ms, the accuracy of integration time is calculated by following formula.

$$\frac{T_{unit}}{T_{set}} \times 100 = \frac{7.8}{2184} \times 100 = 0.36\%$$

The specification of compensated sensitivity is defined as 0.36% accuracy.

KPIC0336EA

**Spectral response (typical example)**

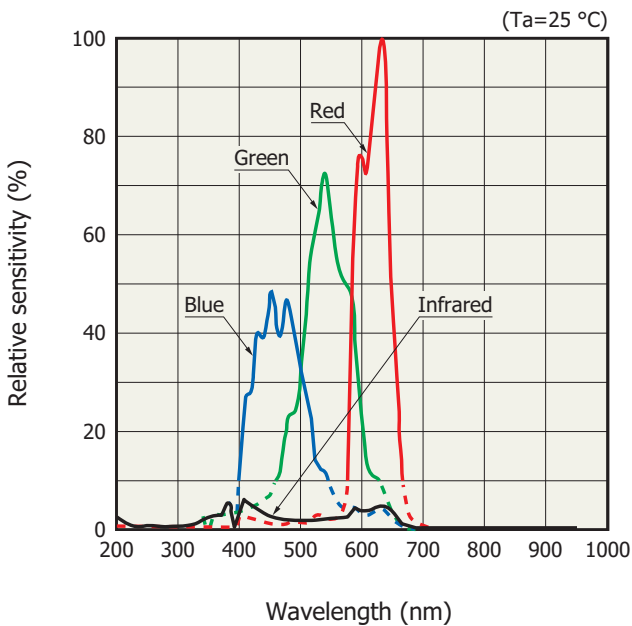

KPIC0169EB

**Count value vs. illuminance (typical example)**

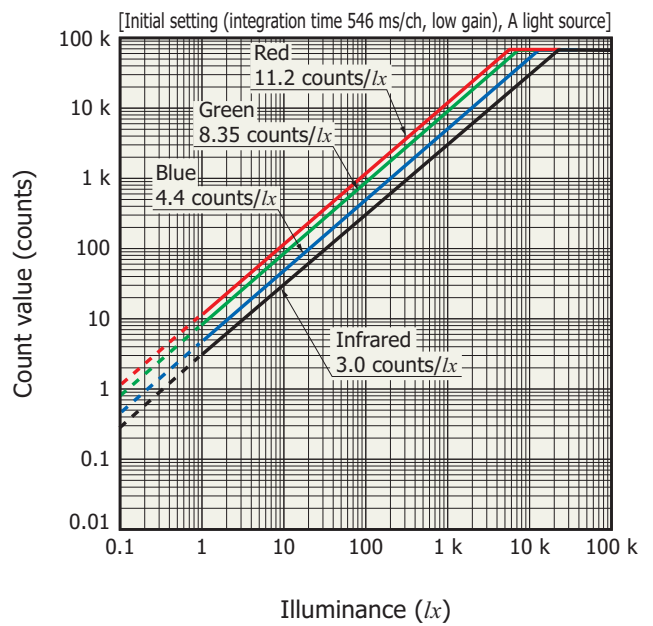

KPIC0170EA

**Block diagram**

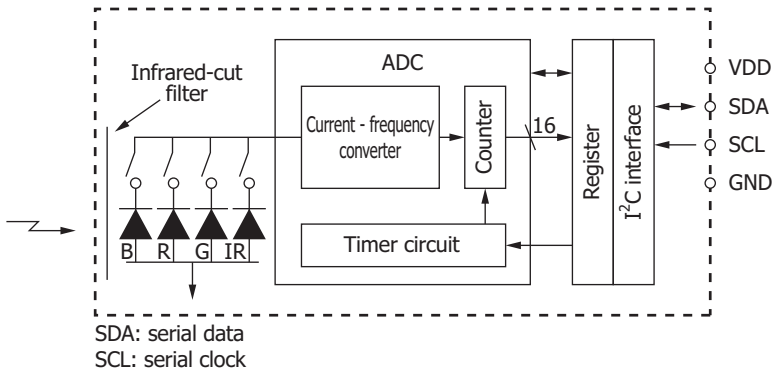

KPIC0152EA

**Timing chart of standby function**

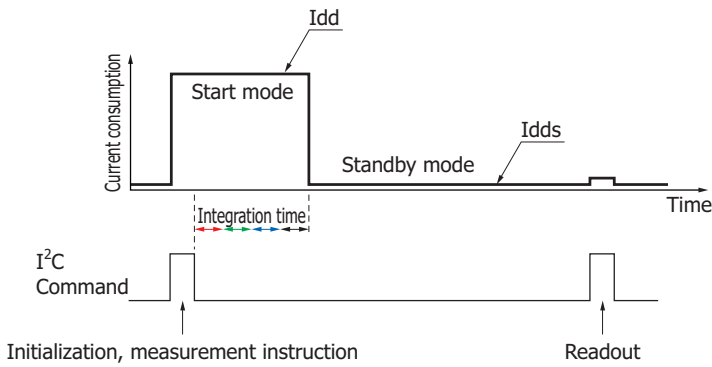

KPIC0158EA

**Connection example**

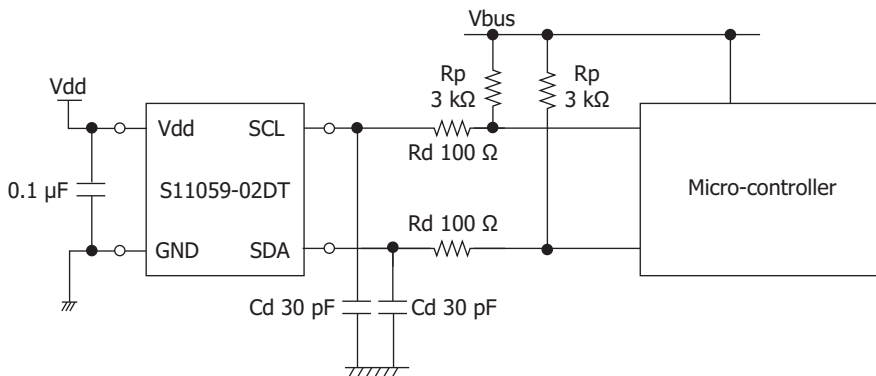

KPIC0185EB

**Dimensional outline (unit: mm)**

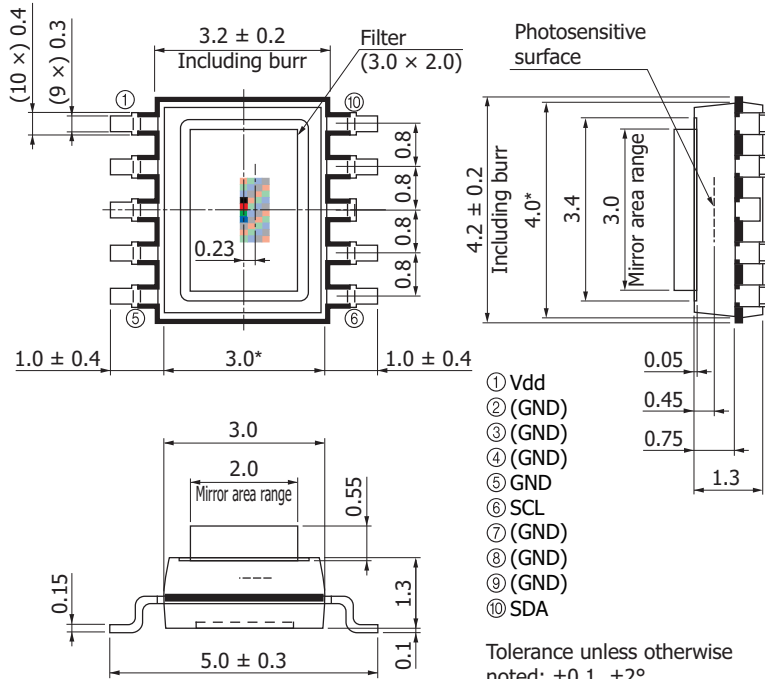

- ① Vdd
- ② (GND)
- ③ (GND)
- ④ (GND)
- ⑤ GND
- ⑥ SCL
- ⑦ (GND)
- ⑧ (GND)
- ⑨ (GND)
- ⑩ SDA

Tolerance unless otherwise noted:  $\pm 0.1$ ,  $\pm 2^\circ$   
 Shaded area indicates burr.  
 Chip position accuracy with respect to package dimensions marked\*  
 $X, Y \leq \pm 0.2$ ,  $\theta \leq \pm 2^\circ$   
 Standard packing state  
 S11059-02DT: reel (1500 pcs/reel)  
 S11059-03DS: stick (100 pcs/stick)

KPICA0090ED

**Details of photosensitive area (unit:  $\mu\text{m}$ )**

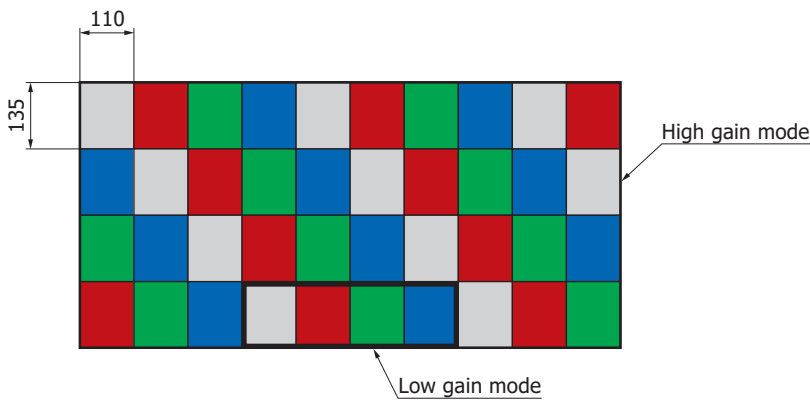

KPIC00153EA



Recommended land pattern (unit: mm)

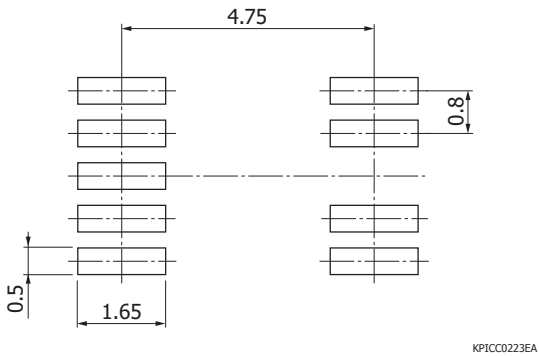

Standard packing specifications (S11059-02DT)

- Reel (conforms to JEITA ET-7200)

Dimension	Hub diameter	Tape width	Material	Electrostatic characteristics
254 mm	80 mm	12 mm	PS (polystyrene)	Conductive

- Embossed tape (unit: mm, material: PS, conductive)

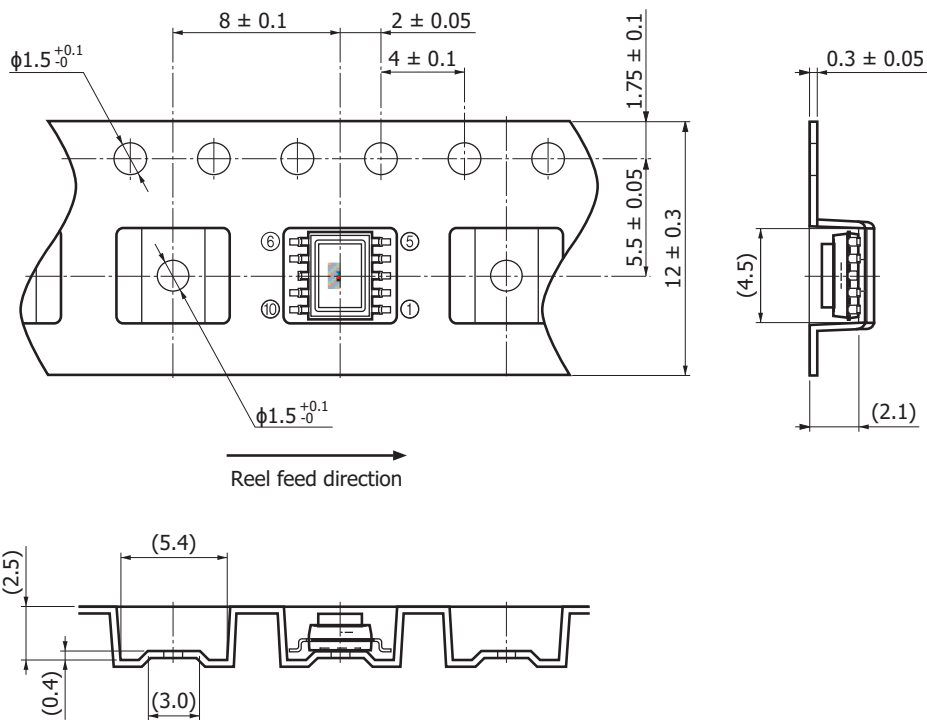

- Packing quantity  
1500 pcs/reel
- Packing type  
Reel and desiccant in moisture-proof packaging (vacuum-sealed)



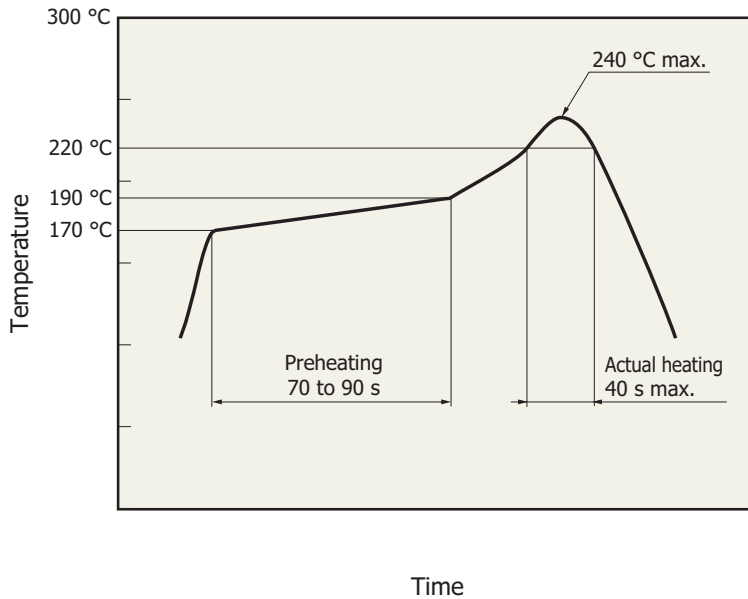











### Measured example of temperature profile with hot-air reflow oven for product testing

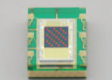

KPICB0164EC

- This product supports lead-free soldering. After unpacking, store it in an environment at a temperature of 30 °C or less and a humidity of 60% or less, and perform soldering within 24 hours.
- The effect that the product receives during reflow soldering varies depending on the circuit board and reflow oven that are used. Before actual reflow soldering, check for any problems by testing out the reflow soldering methods in advance.

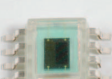
### Lineup of RGB color sensors

Type no.	Type	Photosensitive area (mm)	Package (mm)	Peak sensitivity wavelength (nm)	Photosensitivity				Photo		
S9032-02	Photodiode	 $\phi 2.0$	4 × 4.8 × 1.8 <sup>t</sup> 6 pin (filter 0.75 <sup>t</sup> )	B 460	B	0.18 (A/W) [ $\lambda=460$ nm]					
				G 540	G	0.23 (A/W) [ $\lambda=540$ nm]					
				R 620	R	0.16 (A/W) [ $\lambda=620$ nm]					
S9702	Photodiode	 1.0 × 1.0	3 × 4 × 1.3 <sup>t</sup> 4 pin (filter 0.75 <sup>t</sup> )	B 460	B	0.18 (A/W) [ $\lambda=460$ nm]					
				G 540	G	0.23 (A/W) [ $\lambda=540$ nm]					
				R 620	R	0.16 (A/W) [ $\lambda=620$ nm]					
S10917-35GT	Photodiode	 1.0 × 1.0	3 × 1.6 × 1.0 <sup>t</sup> COB (on-chip filter)	B 460	B	0.2 (A/W) [ $\lambda=460$ nm]					
				G 540	G	0.23 (A/W) [ $\lambda=540$ nm]					
				R 620	R	0.17 (A/W) [ $\lambda=620$ nm]					
S10942-01CT	Photodiode	 1.0 × 1.0	3 × 1.6 × 1.0 <sup>t</sup> COB (on-chip filter)	*	B	0.21 (A/W) [ $\lambda=460$ nm]					
					G	0.25 (A/W) [ $\lambda=540$ nm]					
					R	0.45 (A/W) [ $\lambda=640$ nm]					
S9706	Digital photo IC	 1.2 × 1.2	4 × 4.8 × 1.8 <sup>t</sup> 6 pin (filter 0.75 <sup>t</sup> )	B 465	Low	B	0.21 (LSB/lx)	High	B	1.9 (LSB/lx)	
				G 540		G	0.45 (LSB/lx)		G	4.1 (LSB/lx)	
				R 615		R	0.64 (LSB/lx)		R	5.8 (LSB/lx)	
S11012-01CR	Digital photo IC	 1.2 × 1.2	3.43 × 3.8 × 1.6 <sup>t</sup> COB (on-chip filter)	*	Low	B	0.3 (LSB/lx)	High	B	2.6 (LSB/lx)	
						G	0.6 (LSB/lx)		G	5.3 (LSB/lx)	
						R	1.4 (LSB/lx)		R	12.9 (LSB/lx)	
S11059-02DT /-03DS	I <sup>2</sup> C compatible color sensor	 0.56 × 1.22	3 × 4.2 × 1.3 <sup>t</sup> 10 pin (on-chip filter)	B 460	Low	B	4.4 (count/lx)	High	B	44.8 (count/lx)	
				G 530		G	8.3 (count/lx)		G	85.0 (count/lx)	
				R 615		R	11.2 (count/lx)		R	117.0 (count/lx)	
				IR 855		IR	3.0 (count/lx)		IR	30.0 (count/lx)	
S13683-02WT	I <sup>2</sup> C compatible color sensor	 1.22 × 0.56	1.75 × 1.25 × 0.48 <sup>t</sup> WL-CSP (on-chip filter)	R 615	Low	R	9.48 (count/lx)	High	R	94.5 (count/lx)	
				G 530		G	7.61 (count/lx)		G	76.2 (count/lx)	
				B 460		B	3.35 (count/lx)		B	31.7 (count/lx)	
				IR 855		IR	1.66 (count/lx)		IR	15.3 (count/lx)	

\* Refer to the spectral response of each product's datasheet.

## Related information

[www.hamamatsu.com/sp/ssd/doc\\_en.html](http://www.hamamatsu.com/sp/ssd/doc_en.html)

### ■ Precautions

- Disclaimer
- Metal, ceramic, plastic package products
- Surface mount type products

Information described in this material is current as of December 2017.

Product specifications are subject to change without prior notice due to improvements or other reasons. This document has been carefully prepared and the information contained is believed to be accurate. In rare cases, however, there may be inaccuracies such as text errors. Before using these products, always contact us for the delivery specification sheet to check the latest specifications.

The product warranty is valid for one year after delivery and is limited to product repair or replacement for defects discovered and reported to us within that one year period. However, even if within the warranty period we accept absolutely no liability for any loss caused by natural disasters or improper product use. Copying or reprinting the contents described in this material in whole or in part is prohibited without our prior permission.

# HAMAMATSU

[www.hamamatsu.com](http://www.hamamatsu.com)

HAMAMATSU PHOTONICS K.K., Solid State Division

1126-1 Ichino-cho, Higashi-ku, Hamamatsu City, 435-8558 Japan, Telephone: (81) 53-434-3311, Fax: (81) 53-434-5184

U.S.A.: Hamamatsu Corporation: 360 Foothill Road, Bridgewater, N.J. 08807, U.S.A., Telephone: (1) 908-231-0960, Fax: (1) 908-231-1218, E-mail: [usa@hamamatsu.com](mailto:usa@hamamatsu.com)

Germany: Hamamatsu Photonics Deutschland GmbH: Arzbergerstr. 10, D-82211 Herrsching am Ammersee, Germany, Telephone: (49) 8152-375-0, Fax: (49) 8152-265-8, E-mail: [info@hamamatsu.de](mailto:info@hamamatsu.de)

France: Hamamatsu Photonics France S.A.R.L.: 19, Rue du Saule Trapu, Parc du Moulin de Massy, 91882 Massy Cedex, France, Telephone: 33-(1) 69 53 71 00, Fax: 33-(1) 69 53 71 10, E-mail: [infos@hamamatsu.fr](mailto:infos@hamamatsu.fr)

United Kingdom: Hamamatsu Photonics UK Limited: 2 Howard Court, 10 Tewin Road, Welwyn Garden City, Hertfordshire AL7 1BW, United Kingdom, Telephone: (44) 1707-294888, Fax: (44) 1707-325777, E-mail: [info@hamamatsu.co.uk](mailto:info@hamamatsu.co.uk)

North Europe: Hamamatsu Photonics Norden AB: Torshamnsgatan 35 16440 Kista, Sweden, Telephone: (46)8-509 031 00, Fax: (46)8-509 031 01, E-mail: [info@hamamatsu.se](mailto:info@hamamatsu.se)

Italy: Hamamatsu Photonics Italia S.r.l.: Strada della Moia, 1 int. 6, 20020 Arese (Milano), Italy, Telephone: (39)02-93 58 17 33, Fax: (39)02-93 58 17 41, E-mail: [info@hamamatsu.it](mailto:info@hamamatsu.it)

China: Hamamatsu Photonics (China) Co., Ltd.: B1201, Jiaming Center, No.27 Dongsanhuan Beilu, Chaoyang District, Beijing 100020, China, Telephone: (86) 10-6586-6006, Fax: (86) 10-6586-2866, E-mail: [hpc@hamamatsu.com.cn](mailto:hpc@hamamatsu.com.cn)

Taiwan: Hamamatsu Photonics Taiwan Co., Ltd.: 8F-3, No. 158, Section2, Gongdao 5th Road, East District, Hsinchu, 300, Taiwan R.O.C. Telephone: (886)03-659-0080, Fax: (886)03-659-0081, E-mail: [info@hamamatsu.com.tw](mailto:info@hamamatsu.com.tw)