

# MEMS mirrors

## Contents

### 1. Overview

- p.01
- 1-1 Structure
  - 1-2 Operating principle
  - 1-3 Drive method

### 2. Operation mode

- p.03
- 2-1 Linear mode
  - 2-2 Non-linear mode
  - 2-3 Mirror types and operation modes

### 3. Specifications

- p.04
- 3-1 One-dimensional type
  - 3-2 Two-dimensional type

### 4. How to use

- p.15
- 4-1 One-dimensional type
  - 4-2 Two-dimensional type

### 5. High-accuracy control

- p.22
- 5-1 Correction curve for optical deflection angle vs. drive current characteristics
  - 5-2 Low-speed operation and high-speed operation
  - 5-3 Linear mode
  - 5-4 Ringing correction
  - 5-5 Temperature correction
  - 5-6 Reproducibility of optical deflection angle

## 1. Overview

Our MEMS mirrors are miniature electromagnetic mirrors that incorporate MEMS technology. Within a magnetic field generated by the magnet, electrical current flowing in the coil surrounding the mirror produces a Lorentz force based on Fleming's left-hand rule, and this force drives the mirror. MEMS mirrors feature a wide optical deflection angle and high mirror reflectivity as well as low power consumption.

### » Description

- ▶ Low voltage operation
- ▶ Wide optical deflection angle of mirror
- ▶ Compact
- ▶ Evaluation circuit (USB interface) available (sold separately)

## 1 - 1 Structure

MEMS mirrors consist of a mirror chip and a magnet. The mirror chip includes a mirror, coil and torsion bars [Figure 1-1]. The mirror chip [Figure 1-2] is formed as a thin film on a portion of a silicon substrate using MEMS technology. Whereas electromagnetic mirrors are usually configured with a magnet surrounding the mirror chip, our MEMS mirrors use a small, powerful magnet positioned under the mirror chip, a design that achieves an ultra-compact size. The magnet is designed to provide an optimal magnetic field to the coil around the mirror. There are two types of MEMS mirrors: a single-axis one-dimensional type and a dual-axis two-dimensional type.

[Figure 1-1] Structure

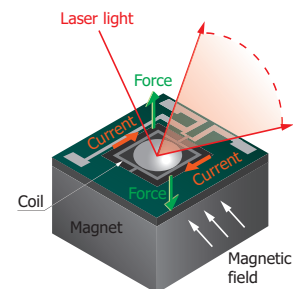

KOTH0058EB

[Figure 1-2] Mirror chip

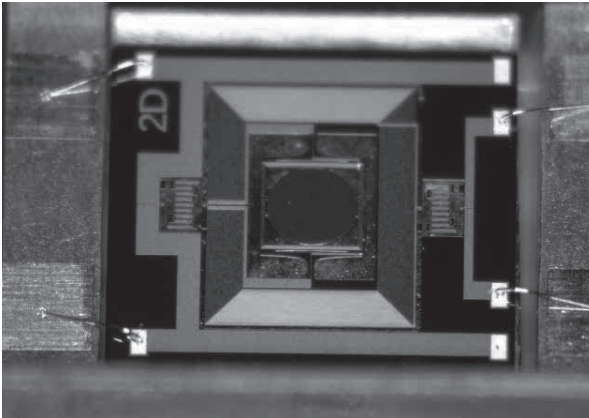

## 1 - 2 Operating principle

The basic operating principle for controlling the angle of the mirror is based on Fleming's left-hand rule [Figure 1-3]. When a coil is placed perpendicular to a magnetic field, and current flows in the coil, force is exerted on the coil. This force is called the Lorentz force, and its magnitude is proportional to the strength of the current and magnetic field.

[Figure 1-3] Operating principle

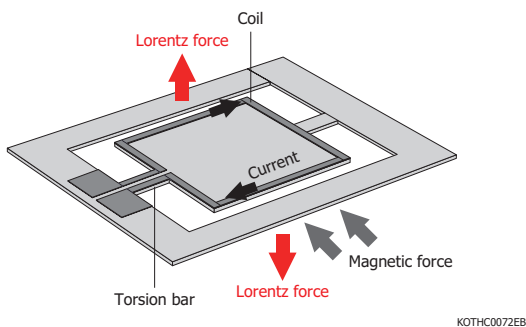

The mirror is supported by beams called torsion bars. The torsion bar serves as the axis of rotation and also as a torsion spring for suppressing mirror rotation. When current flows through the coil around the mirror, a torque that rotates the mirror (Lorentz force) is produced, and an elastic force of the torsion bar spring is exerted in the opposite direction. The rotation of the mirror stops when these two forces balance each other. The mirror's angle can be changed by varying the magnitude of the current flowing through the coil to control the torque.

MEMS mirrors resonate at their characteristic oscillation frequencies, which are determined by their mass, structure, and spring constant. Using resonance makes it possible to obtain large mirror deflection angles very quickly using only a small current. Since mirror movements are represented as sine waves and complex movements are not possible when resonating, resonance is used for applications where constant reciprocating motion suffices.

The operation mode that uses resonance is called resonant mode, and the mode that does not use resonance is called non-resonant mode. Because non-resonant mode is used for linear operation that takes advantage of the excellent linearity between the drive current and optical deflection angle, it is also called linear mode. Note that resonant mode is also called non-linear mode.

## 1 - 3 Drive method

There are several general MEMS mirror drive methods [Table 1-1]. Our MEMS mirrors are electromagnetic. This method requires only a low voltage to drive both resonant mode and non-resonant mode, and offers excellent balance. Electromagnetic MEMS mirrors can be used in a wide variety of applications, such as in portable battery-powered devices.

[Table 1-1] General MEMS mirror drive methods

Drive method	Electrostatic method	Piezoelectric method	Electromagnetic method (One-dimensional type)
Rotational torque	Low	High	Medium
Drive voltage	50 V to 150 V	20 V to 50 V	-
Drive current	-	-	Approx. 20 mA
Power consumption	<<1 mW (Approx. 0 mA)	High (Approx. 20 mA)	Approx. 100 mW (Approx. 5 V)
Optical deflection angle (Non-linear mode)	$\pm 10^\circ$	$\pm 25^\circ$	$\pm 25^\circ$
Optical deflection angle (Linear mode)	$\pm 5^\circ$	Difficult to control	$\pm 15^\circ$

## 2. Operation mode

As mentioned in section 1-2, "Operating principle," there are two operation modes for MEMS mirrors: linear mode (non-resonant mode) and non-linear mode (resonant mode).

### 2-1 Linear mode

Linear mode is used to accurately control the mirror's optical deflection angle by means of the drive current. The relationship between the drive current and optical deflection angle of the mirror exhibits excellent linearity, and the angle reproducibility relative to the drive current is high. Note that linear mode is not suitable for high-speed operation. The mirror must be driven at a frequency lower than the specific resonant frequency of the mirror to prevent resonance. Normally, a frequency in the range of 1/10 the resonant frequency (or less) to 1/5 the resonant frequency (or less) is recommended.

### 2-2 Non-linear mode

Non-linear mode is a resonance operation mode at the resonant frequency of the mirror. High-speed operation is possible, but the optical deflection angle of the mirror cannot be controlled with high accuracy. Non-linear mode is used to drive a non-linear mode MEMS mirror or to drive a non-linear mode axis. Driving a mirror in non-linear mode requires the application of either a sine-wave or square-wave current signal at the same frequency as the mirror's resonant frequency.

In non-linear mode, even if a square wave is applied, the deflection angle of the mirror operates as a sine wave. Further, a phase lag occurs in the optical deflection angle relative to the drive current.

### 2-3 Mirror types and operation modes

There are two types of MEMS mirrors: a single-axis one-dimensional type and a dual-axis two-dimensional type. The two-dimensional mirrors come in various types with different modes for each axis [Table 2-1].

Currently, Hamamatsu provides a portion of the MEMS mirrors in Table 2-1. Contact us for future product release plans.

[Table 2-1] MEMS mirror types

Type	Operation mode		Main application
	Slow axis	Fast axis	
One-dimensional (single axis)	Linear mode	-	Measurement
	-	Non-linear mode	High-speed measurement
Two-dimensional (dual axis)	Linear mode	Linear mode	Measurement
	Linear mode	Non-linear mode	Image display
	Non-linear mode	Non-linear mode	High-speed image display

## 3. Specifications

### 3-1 One-dimensional type

#### » Definition of optical deflection angle

Hamamatsu defines the MEMS mirror deflection angle using optical deflection angle, not mechanical deflection angle. The optical deflection angle is an angle formed between the incident light and reflected light when a light beam from a light source is directed at a mirror. It is twice the mechanical deflection angle, which is the tilt angle of the mirror [Figure 3-1].

[Figure 3-1] Optical deflection angle

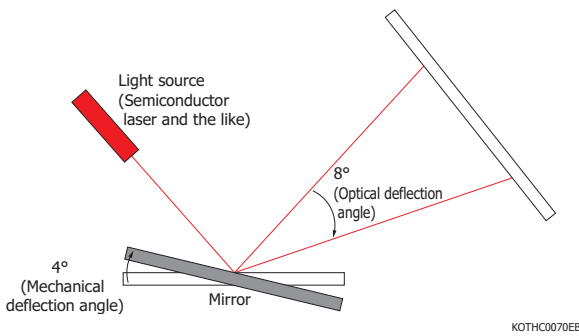

#### » Absolute maximum ratings

Table 3-1 shows an example of the absolute maximum ratings of a MEMS mirror (S12237-03P: linear mode one-dimensional MEMS mirror). MEMS mirrors must be used within the absolute maximum ratings.

[Table 3-1] Absolute maximum ratings (S12237-03P)

(Tcase=25 °C, unless otherwise noted)

Parameter	Symbol	Value	Unit
Drive current	Is	±20	mA
Optical deflection angle	θs	±18	°
Operating temperature	Topr	-40 to +80	°C
Storage temperature	Tstg	-40 to +85	°C

The maximum optical deflection angle is defined as the angle that if the mirror deflection angle were to be increased further, the mirror would be damaged as a result of the mirror making contact with the magnet or the other parts.

The maximum drive current is defined as the current that may melt the coil wires. When the drive current is increased, the maximum optical deflection angle is reached

before the drive current reaches its absolute maximum rating. The drive current must not be increased to its absolute maximum rating. The magnitude of the drive current must be observed carefully so that the maximum optical deflection angle is not exceeded. Particularly in high-speed operation, even when the mirror is driven with the same current, the maximum optical deflection angle may be exceeded as the resonant frequency is approached, causing damage to the mirror. The deflection angle, especially at the resonant frequency, is several tens of times higher than that at low frequencies, which makes it difficult to control. As such, do not drive the mirror at the resonant frequency for linear mode MEMS mirrors and axes.

Non-linear mode MEMS mirrors and axes must be driven at the resonant frequency. Note that in non-linear mode, the optical deflection angle when the mirror is driven at the resonant frequency differs significantly from the optical deflection angle at other frequencies. Driving the mirror at frequencies other than the resonant frequency may produce unexpected optical deflection angles even when the drive current is adjusted to obtain the optical deflection angle under the recommended operating conditions and may damage the mirror.

When driving a non-linear mode MEMS mirror or axis, use drive signals produced by a reference signal generator with excellent temperature stability.

#### » Recommended operating conditions

The recommended operating conditions are for guaranteeing, “Electrical and optical characteristics [Table 3-3].” Note that even if the recommended operating conditions are exceeded slightly, as long as the absolute maximum ratings are not exceeded, the MEMS mirror will not be damaged.

Table 3-2 shows the recommended operating conditions for the S12237-03P. The recommended optical deflection angle is ±15 degrees, but the absolute maximum rating is ±18 degrees, so there is about a 3-degree margin. Further, the recommended drive frequency is DC to 100 Hz. For frequencies higher than 100 Hz, the MEMS mirror operates in non-linear mode and may be damaged, so we recommend that you use it within the recommended operating condition range.

[Table 3-2] Recommended operating conditions (S12237-03P)

Parameter	Min.	Typ.	Max.	Unit
Operation mode	Linear mode			-
Optical deflection angle	-15	-	+15	degrees
Drive frequency	DC	-	100	Hz

## » Electrical and optical characteristics

Table 3-3 shows the electrical and optical characteristics of the S12237-03P.

[Table 3-3] Electrical and optical characteristics (S12237-03P)

(Recommended operating conditions unless otherwise noted)

Parameter	Symbol	Condition	Min.	Typ.	Max.	Unit	
Mirror size	A		φ2.59	φ2.60	φ2.61	mm	
Drive current	Is	Ta=25 °C fs=DC	θs=-15°	-17	-15	-13	mA
			θs=+15°	+13	+15	+17	
Resonant frequency	fs-R	Is=0.6 mA p-p	500	530	560	Hz	
Reflectance	Or	λ=450 to 650 nm	80	-	-	%	
Coil resistance	Rs	Ta=25 °C, Is=0.2 mA	135	165	195	Ω	

### ⚙ Mirror reflectivity

Aluminum metal is deposited on the mirror surface of the MEMS mirror providing high reflectance in the visible region. Figure 3-2 shows the relationship between wavelength and reflectance. For the three primary colors of red, blue, and green, reflectance is 85% or higher. Note that reflection from the chip surface outside the mirror area is not zero, so if the light source's beam size is greater than the mirror size, the reflection appears as stray light on the target. Design the optical system so that the beam size is smaller than the mirror size.

[Figure 3-2] Mirror reflectivity

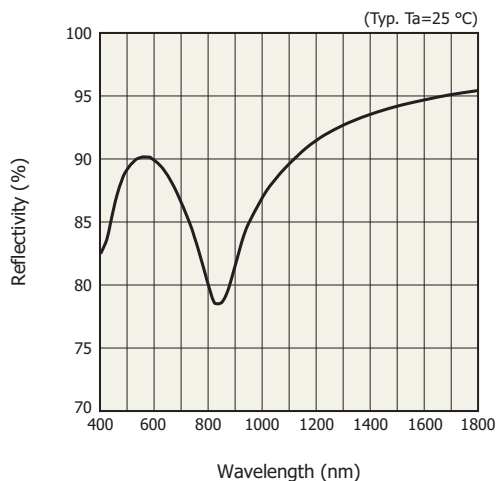

### ⚙ Drive current

Drive current is an important parameter that defines the optical deflection angle. Drive current, in linear mode and non-linear mode, is defined as values that can achieve the minimum and maximum values of the

optical deflection angle under recommended operating conditions.

Figure 3-3 shows the optical deflection angle versus drive current characteristics of the S12237-03P. The relationship between the optical deflection angle and drive current can be approximated by a straight line. From the graph that connects the minimum and maximum drive currents with a straight line, the current for a given deflection angle can be calculated. This method enables the mirror to be controlled to any optical deflection angle with an accuracy of 1° or less (if you want to control the mirror with even higher accuracy, see chapter 5, "High-accuracy control.")

In Figure 3-3, the drive current's polarity represents the direction of the drive current flowing through the MEMS mirror coil. The drive current's direction can be used to change the direction of the optical deflection angle. In Figure 3-3, the drive current in one direction produces 15° of optical deflection angle and in both positive and negative directions produce a total of 30°.

Note that the optical deflection angle characteristics of linear mode MEMS mirrors are measured using DC operation.

[Figure 3-3] Optical deflection angle vs. drive current (S12237-03P)

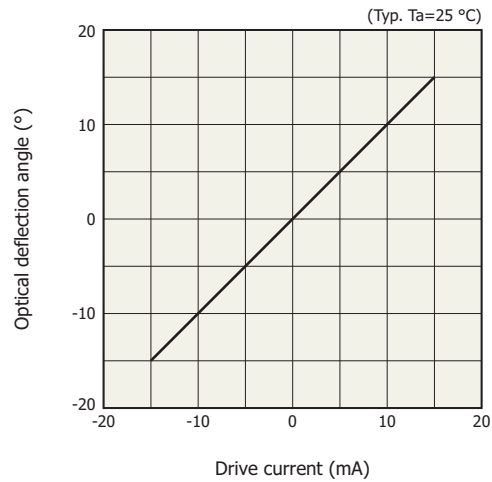

KOTH80004EC

[Figure 3-4] Drive current and optical deflection angle directions (S12237-03P)

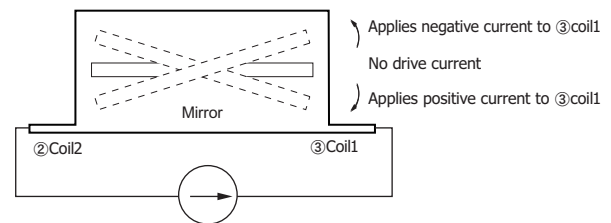

KOTH0071EC

### ⚙ Resonant frequency

Resonant frequency in linear mode serves as a guide for determining the range of drive frequencies. Figure

3-5 shows the frequency characteristics of the S12237-03P. At the resonant frequency, an extremely small drive current of 0.6 mA produces a large optical deflection angle. A small shift in the drive current can cause the absolute maximum rating of the optical deflection angle to be exceeded and may damage the mirror. Never drive the mirror at a frequency near the resonant frequency in linear mode.

[Figure 3-5] Frequency characteristics (S12237-03P)

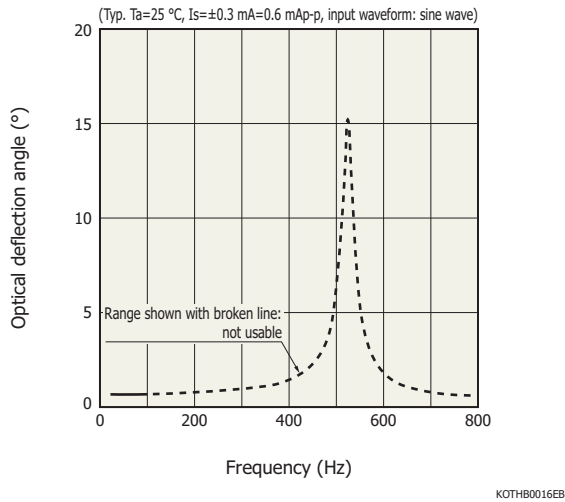

#### ⚙️ Drive frequency

Figure 3-6 shows the frequency characteristics of the optical deflection angle in the low frequency region. Here, a sine wave with a 15 mA current amplitude is driving the mirror. At the recommended drive frequencies of 100 Hz or less, the graph shows nearly flat frequency characteristics, but as the drive frequency is increased, the optical deflection angle increases. At around 180 Hz, the optical deflection angle's absolute maximum rating of 18° is reached, and the possibility of damaging the mirror increases. You must drive the MEMS mirror under the recommended operating conditions (drive frequency: DC to 100 Hz).

[Figure 3-6] Optical deflection angle vs. drive frequency (S12237-03P)

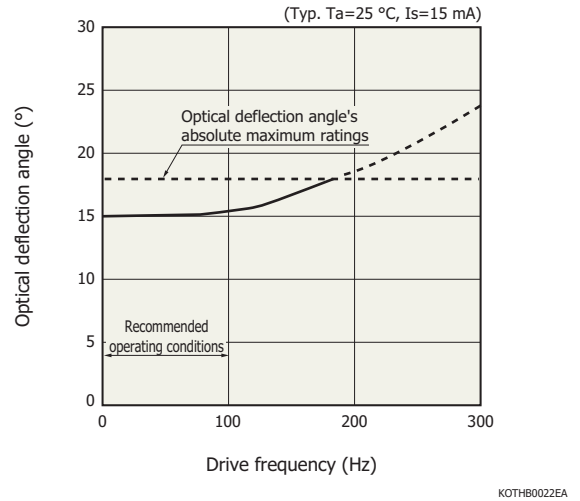

#### ⚙️ Coil resistance

The inductive component due to the coil wiring around the MEMS mirror is extremely small. It is less than several microhenries for linear mode MEMS mirrors and 0.1 μH or less for non-linear mode MEMS mirrors. As such, at the linear mode frequency region around several hundred hertz and at the non-linear mode frequency region around several megahertz, the coil impedance is 0.1 Ω or less, and this can be ignored when compared to the pure resistivity of the coil. In most cases, the coil resistance can be assumed to be its pure resistance. Note that the coil resistance indicated in the electrical and optical characteristics is for 25 °C.

#### ⚙️ Temperature characteristics

In MEMS mirrors, the coil resistance, the magnetic force of the magnet, the resonant frequency, and the like have temperature characteristics. To control the mirror's optical deflection angle with high accuracy over a wide temperature range, you must pay attention to the temperature characteristics.

Figure 3-7 shows the temperature characteristics of resonant frequency for the S12237-03P.

[Figure 3-7] Temperature characteristics of resonant frequency (S12237-03P)

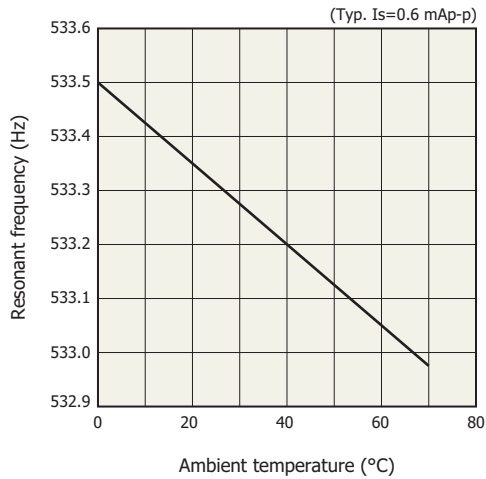

KOTHB0023EA

In the operating temperature range, the resonant frequency varies by about 0.1 to 0.2%, and the effect on the characteristics can be ignored.

Figure 3-8 shows the temperature characteristics of coil resistance for the S12237-03P. When the MEMS mirror is driven by a voltage source, the temperature characteristics of the coil resistance cannot be ignored. When the MEMS mirror is driven by a current source, the temperature characteristics of the coil resistance can be ignored. Therefore, we recommend that the MEMS mirror be driven by a current source.

[Figure 3-8] Temperature characteristics of coil resistance (S12237-03P)

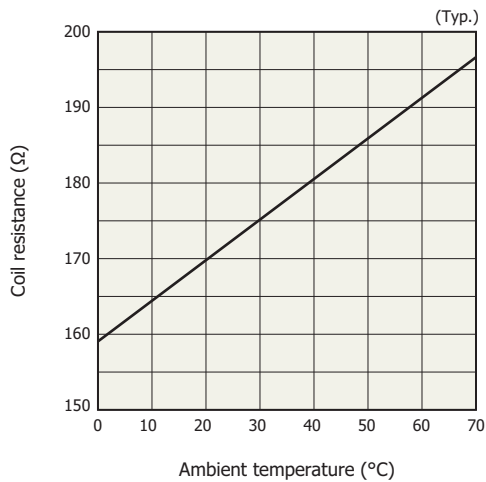

KOTHB0024EA

The temperature characteristics of the magnet's magnetic force are not easy to measure. As such, the changes in the magnetic force due to the magnet temperature is estimated from the changes in the optical deflection angle due to temperature. Figure 3-9 shows the changes in the optical deflection angle relative to temperature.

[Figure 3-9] Temperature characteristics of optical deflection angle (S12237-03P)

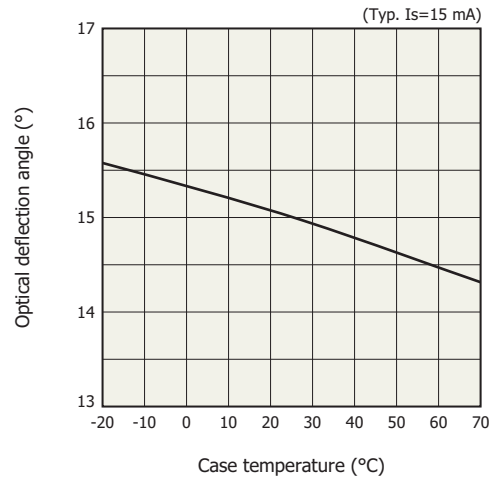

KOTHB0086EA

In the measurement of Figure 3-9, a current source was used. Current is not affected by coil resistance changes due to temperature. Therefore, it can be assumed that the optical deflection angle is changing due to the changes in the magnetic force caused by temperature.

In Figure 3-9, we can see that the changes in the magnetic force due to temperature are causing a deflection angle error of about  $\pm 0.5^\circ$ . Because the coil resistance changes according to temperature, the chip temperature can be monitored by reading the coil resistance. And this makes temperature correction possible.

## 3 - 2 Two-dimensional type

### » Definition of optical deflection angle

The two-dimensional type MEMS mirror S13989-01H has a window material that is tilted  $20^\circ$  with respect to the scanning direction of the slow axis in order to achieve a highly reliable hermetic seal package. The tilt of the window material is set so that the laser light reflected from the front or back of the window does not enter the mirror scan's projection range [Figure 3-10].

[Figure 3-10] Effect of tilting window material

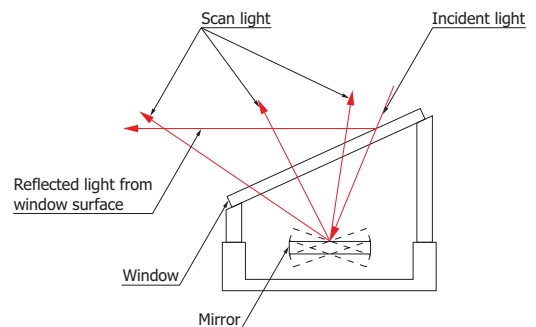

KOTHC0082EA



The optical deflection angle of the MEMS mirror is defined as twice the mechanical deflection angle. Since the laser light refracts when it passes through the tilted window material, the path of the mirror-reflected light deviates depending on the laser light's incident angle on the mirror and the mechanical deflection angle [Figure 3-11]. The following shows how to calculate the amount of light path deviation of the mirror-reflected light.

[Figure 3-11] Light path deviation of the mirror-reflected light

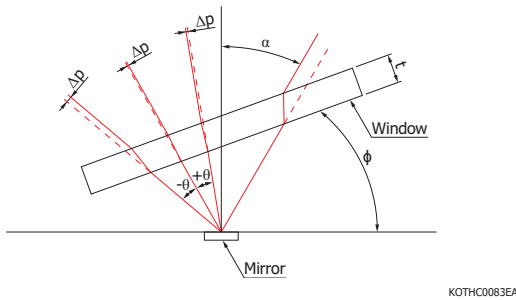

The amount of light path deviation  $\Delta p$  [mm] is expressed by equation (3-1).

$$\Delta p = \frac{t \sin\{\gamma - \arcsin(\frac{\sin\gamma}{n})\}}{\cos\{\arcsin(\frac{\sin\gamma}{n})\}} \times 100 \dots\dots\dots (3-1)$$

- t : window thickness [mm]
- $\gamma$  :  $(\alpha - \phi) - \theta$
- $\alpha$  : incident angle of the laser light on the mirror [°]
- $\phi$  : angle of the window material relative to the mirror [°]
- $\theta$  : optical deflection angle of the mirror-reflected light [°]
- n : refractive index of window material (1.526 when  $\lambda=546$  nm)

In Figure 3-12, we assume a case in which laser light is projected at a flat screen that is tilted by  $\beta^\circ$  with respect to the mirror (mechanical deflection angle:  $0^\circ$ ). The amount of position deviation on the screen  $\Delta\alpha$  [mm] is expressed by equation (3-2).

$$\Delta\alpha = \frac{\Delta p}{\cos\eta} \dots\dots\dots (3-2)$$

$$\eta = (\alpha - \beta) - \theta$$

[Figure 3-12] Position deviation on screen

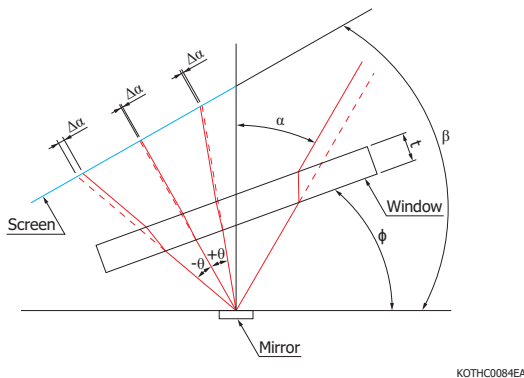

Depending on the incident angle of the laser light on the mirror and the mechanical deflection angle, the light path deviation due to refraction when passing through the material must be considered.

Figure 3-13 shows the light path deviation when the optical deflection angle changes in the scanning direction of the slow axis. When the incident angle on the mirror is  $20^\circ$ , the light path deviation is  $\pm 100 \mu\text{m}$  or less.

[Figure 3-13] Light path deviation vs. optical deflection angle (slow axis)

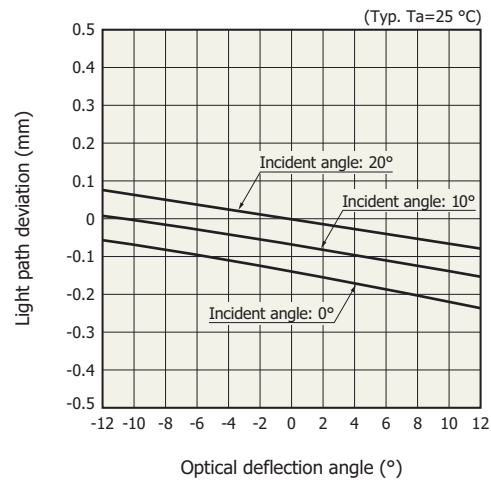
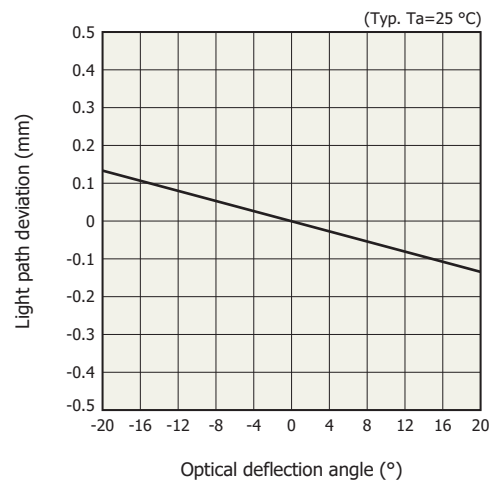

Figure 3-14 shows the light path deviation when the optical deflection angle changes in the scanning direction of the fast axis. The light path deviation is not affected by the incident angle on the mirror. Note that light path deviation occurs due to light refraction caused by the window material ( $\pm 180 \mu\text{m}$  or less).

[Figure 3-14] Light path deviation vs. optical deflection angle (fast axis)



### » Absolute maximum ratings

Table 3-4 shows the absolute maximum ratings of the two-dimensional type MEMS mirror S13989-01H. MEMS



mirrors must be used within the absolute maximum ratings.

[Table 3-4] Absolute maximum ratings (S13989-01H)

(Ta=25 °C unless otherwise noted)

Parameter	Symbol	Value	Unit	
Fast axis	Optical deflection angle	θf	±22	°
Slow axis	Drive current	Is_dc	±100	mAdc
	Optical deflection angle	θs_max	±14	°
Power consumption	Pcoil	520	mW	
Operating temperature	Topr	-20 to +60	°C	
Storage temperature	Tstg	-40 to +85	°C	

The fast axis is exclusive to non-linear mode and must be driven at the resonant frequency. The optical deflection angle when the mirror is driven at a non-resonant frequency differs significantly from the optical deflection angle when driven at the resonant frequency. Driving the mirror at frequencies other than the resonant frequency may result in unexpected optical deflection angles even when the drive current is set to obtain the optical deflection angle under the recommended operating conditions, and may damage the mirror.

The slow axis is exclusive to linear mode. The drive current must be set so that the optical deflection angle does not exceed the absolute maximum rating. In addition, in high-speed operation, the maximum optical deflection angle may be exceeded as the resonant frequency is approached, causing damage to the mirror. Do not drive the slow axis at the resonant frequency because the optical deflection angle at the resonant frequency will be several hundred times that at a low frequency and cannot be controlled.

The slow-axis drive current at the absolute maximum rating is a DC current that damages wiring. Since driving the slow axis with a DC current may reduce the service life, driving with an AC current is recommended.

Power consumption indicates the total power consumption of the fast-axis and slow-axis coils. Since the wiring may be damaged by the heat generated by the coil, set the drive currents for the fast and slow axes so that the absolute maximum rating of power consumption is not exceeded. Power consumption is given by equation (3-3).

$$P_{coil} = (R_s \times I_{s\_rms}^2 + R_f \times I_{f\_rms}^2) \times X \times 1000 \text{ [mW]} \dots\dots\dots (3-3)$$

- R<sub>s</sub> : coil resistance of slow axis [Ω]
- I<sub>s\_rms</sub>: rms value of slow-axis drive current [A]
- R<sub>f</sub> : coil resistance of fast axis [Ω]
- I<sub>f\_rms</sub>: rms value of fast-axis drive current [A]
- X : correction factor (=2)

When the slow axis is operated by a drive current with an arbitrary waveform, I<sub>s\_rms</sub> is given by equation (3-4).

$$I_{s\_rms} = \sqrt{\frac{1}{n} \sum_{i=0}^{n-1} I_s(i)^2} \dots\dots\dots (3-4)$$

- i : data index
- n : number of drive current data values
- I<sub>s</sub>(i): ith drive current [A]

## ➤ Recommended operating conditions

The recommended operating conditions [Table 3-5] are for guaranteeing the electrical and optical characteristics [Table 3-6]. If the recommended operating conditions are exceeded slightly, as long as the absolute maximum ratings are not exceeded, the MEMS mirror will not be damaged. Note that if the drive frequency of the slow axis exceeds 100 Hz, the MEMS mirror will be in non-linear mode, which may damage the MEMS mirror, so we recommend using it under the recommended operating conditions (100 Hz or less).

[Table 3-5] Recommended operating conditions (S13989-01H)

Parameter	Min.	Typ.	Max.	Unit	
Fast axis	Incident angle	-15	0	+15	°
	Optical deflection angle	-20	-	+20	°
	Drive frequency	Resonant frequency		Hz	
Slow axis	Incident angle	-13	+20	+25	°
	Optical deflection angle	-12	-	+12	°
	Drive frequency	10	-	100	Hz

The incident angle in the recommended operating conditions is the angle of incident light on the mirror with an optical deflection angle of 0°. It is an angle at which the reflected laser light can pass through the effective area of the window material when a laser collimated to φ1 mm is incident on the mirror and scanned with the recommended optical deflection angle. Figure 3-15 shows the definition of the incident angle. Figure 3-16 shows the effective area of the window material.

[Figure 3-15] Definition of incident angle

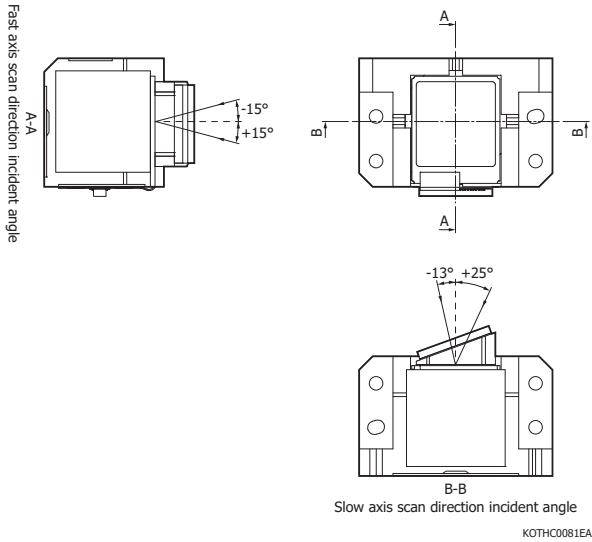

[Figure 3-16] Effective area of window material

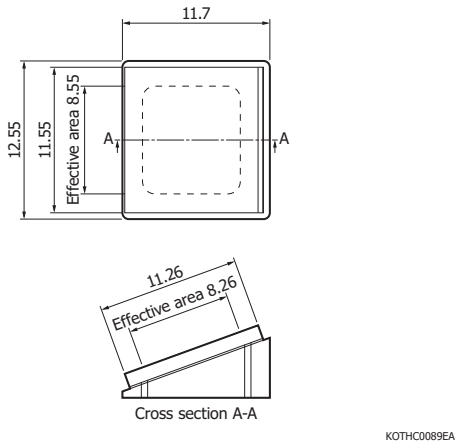

## » Electrical and optical characteristics

Table 3-6 shows the electrical and optical characteristics of the S13989-01H.

[Table 3-6] Electrical and optical characteristics (S13989-01H)

(Recommended operating conditions unless otherwise noted)

Parameter	Symbol	Condition	Min.	Typ.	Max.	Unit
Mirror size	A		φ1.21	φ1.23	φ1.25	mm
Transmittance of window material	T	$\theta_{in}=0$ to $+43^\circ$ $\lambda=460$ to $640$ nm	95	-	-	%
Fast axis	Resonant frequency	$T_a=25^\circ\text{C}$ , $\theta_f=\pm 20^\circ$ $I_s=0$ mA, square wave	28.6	29.3	30.0	kHz
	Drive current	$T_a=25^\circ\text{C}$ , $f_f=f_f-r$ $\theta_f=\pm 20^\circ$ , $I_s=0$ mA square wave	12	22	34	mAmp.
	Coil resistance	$T_a=25^\circ\text{C}$ , $I_f=0.1$ mA $I_s=0$ mA	7.5	10.5	13.5	$\Omega$
Slow axis	Resonant frequency	$T_a=25^\circ\text{C}$ $I_s=\pm 0.3$ mA sine wave	525	575	625	Hz
	Drive current	$T_a=25^\circ\text{C}$ $f_s=60$ Hz sine wave $I_f=0$ mA	$\theta_s=+12^\circ$ 140	175	210	mAmp.
		$\theta_s=-12^\circ$ -210	-175	-140		
Coil resistance	$T_a=25^\circ\text{C}$ , $I_f=0$ mA $I_s=0.1$ mA	6	8	10	$\Omega$	

### ⚙ Mirror reflectivity

Aluminum alloy is deposited on the mirror of the S13989-01H providing high reflectance in the visible region. Reflectance of 80% or more is achieved for red, blue, and green [Figure 3-17]. If the beam size of the incident light is larger than the mirror size, stray light reflected from the chip surface other than the mirror will occur. The optical system must be designed so that the beam size is smaller than the mirror size.

[Figure 3-17] Mirror reflectance vs. wavelength

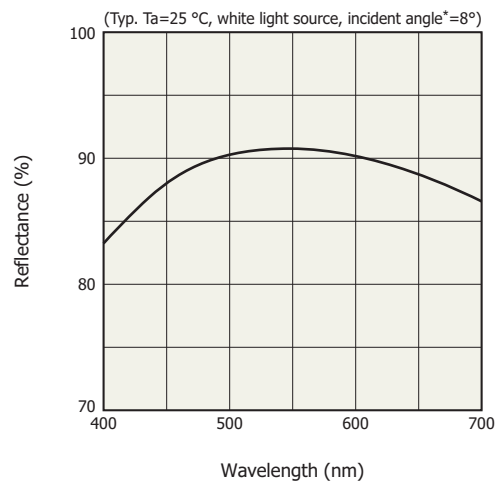

\* Incident angle of light to the mirror

KOTHB0060EA

### ⚙ Transmittance of window material

Figure 3-18 shows the spectral transmittance characteristics of the S13989-01H window material.

[Figure 3-18] Spectral transmittance characteristics of window materials

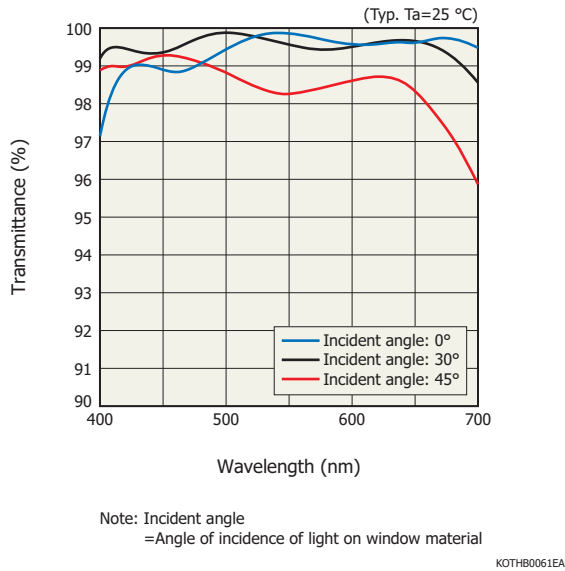

### ⚙️ Drive current (fast axis)

The fast-axis drive current given in the table of electrical and optical characteristics is defined as a value at which the maximum optical deflection angle can be obtained under the recommended operating conditions. Figure 3-19 shows the optical deflection angle versus the drive current characteristics when a single fast axis is driven. For the fast axis, the drive frequency must be set to the resonant frequency. The relationship between the optical deflection angle and drive current of the fast axis is non-linear.

[Figure 3-19] Optical deflection angle vs. drive current (S13989-01H, fast axis)

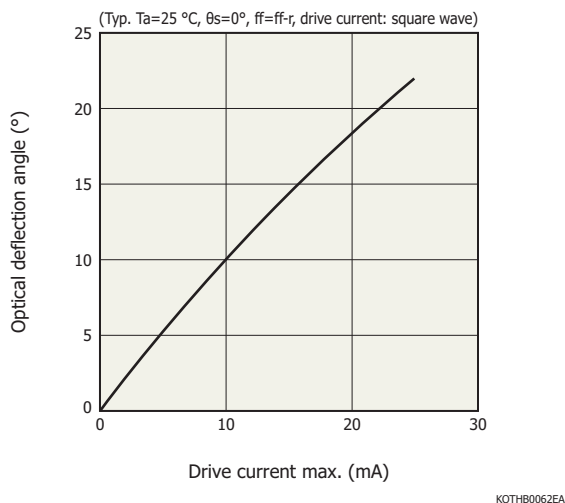

The fast-axis drive current varies depending on the optical deflection angle and the drive current frequency of the slow axis. Figure 3-20 shows changes in the fast-axis drive current when the optical deflection angle of the slow axis changes. This is because the amount of heat generated by the coil changes due to the drive current of

the slow axis, which causes the torsion bar's mechanical characteristics to change. Because the relationship between the drive current and the optical deflection angle of the fast axis varies depending on the slow-axis drive current, the fast-axis drive current needs to be adjusted.

[Figure 3-20] Drive current (fast axis) vs. optical deflection angle (slow axis)

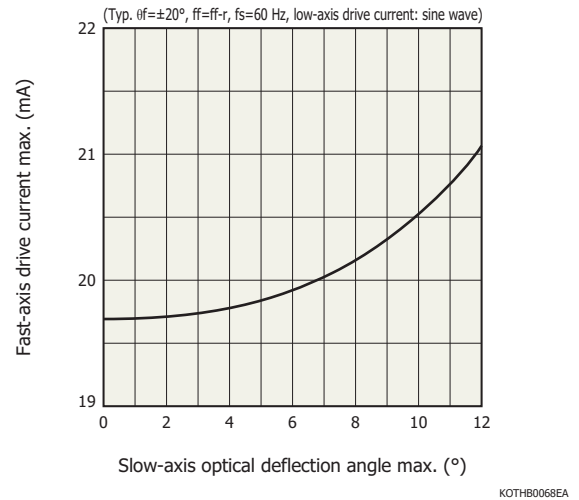

### ⚙️ Resonant frequency (fast axis)

The fast axis exclusive to non-linear mode must be driven at the resonant frequency. Figure 3-21 shows the frequency characteristics of the fast axis near the resonant frequency. Figure 3-21 shows the characteristics (hardening) in which the frequency characteristics are tilted to the high frequency side. Hardening occurs due to the mechanical properties of the torsion bars. If the drive frequency shifts to the higher frequency side of the resonant frequency, the optical deflection angle decreases drastically.

The resonant frequency varies depending on the optical deflection angle amplitude, slow-axis drive conditions, ambient temperature, and changes in torsion bar mechanical properties over time. Operating the fast axis stably at the resonant frequency requires performing feedback control to monitor the resonance state and adjust the drive frequency to the resonant frequency.

[Figure 3-21] Optical deflection angle vs. drive frequency (fast axis)

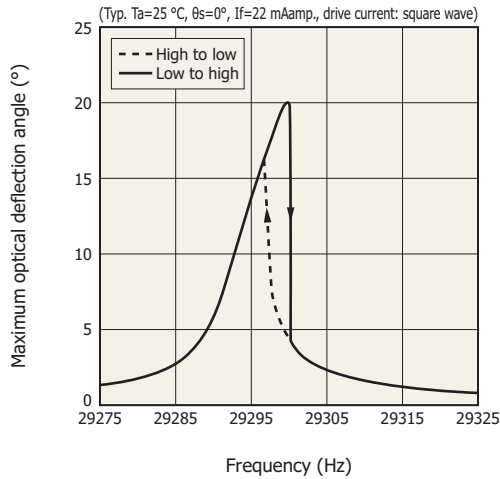

KOTHB0064EA

### ⚙ Back electromotive force (fast axis)

When the fast axis is operating at the resonant frequency, back electromotive force is generated in the fast- and slow-axis coils. Monitoring the amplitude of this back electromotive force allows the amplitude of the fast axis's optical deflection angle to be determined.

Figure 3-22 shows the timing chart (fast axis) of the drive current, optical deflection angle, and back electromotive force. When the fast axis is operating at the resonant frequency, the timing of the back electromotive force and drive current is the same, and the mirror phase is delayed by  $90^\circ$  relative to this timing. The back electromotive force is monitored at the  $1/4$  cycle point of the drive frequency (resonant frequency).

[Figure 3-22] Timing chart (fast axis) of the drive current, optical deflection angle, and back electromotive force

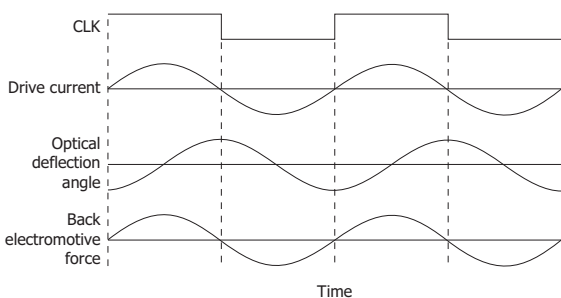

KOTHC0090EA

Figures 3-23 and 3-24 show the relationship between the back electromotive force and optical deflection angle of the fast and slow axes. This relationship is linear, and the back electromotive force can be converted into the optical deflection angle of the fast axis. The back electromotive force is related to magnetic force. And since magnetic force varies depending on the ambient temperature, temperature correction is necessary to obtain accurate back electromotive force.

[Figure 3-23] Back electromotive force vs. optical deflection angle (fast axis)

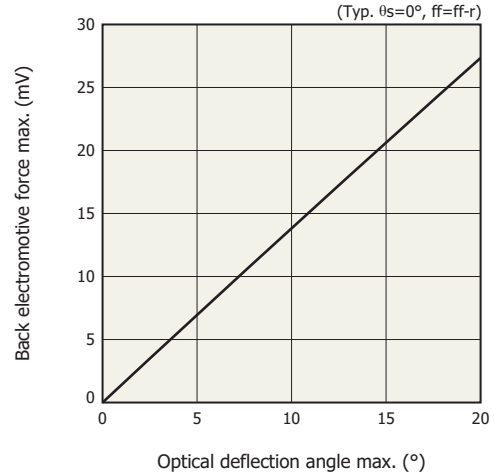

KOTHB0069EA

[Figure 3-24] Back electromotive force vs. optical deflection angle (slow axis)

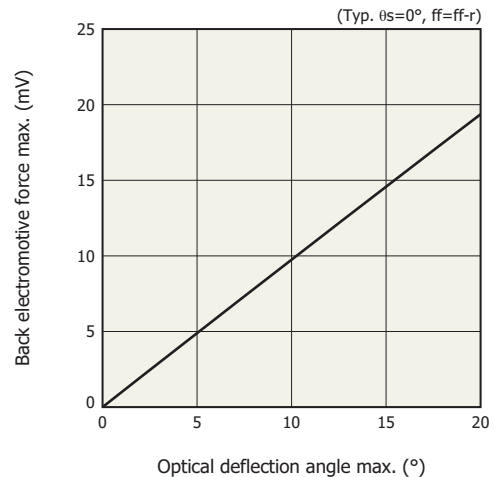

KOTHB0070A

### ⚙ Drive current (slow axis)

The slow-axis drive current given in the table of electrical and optical characteristics is defined as a value at which the minimum and maximum optical deflection angles can be obtained under the recommended operating conditions in linear mode.

The optical deflection angle versus the drive current characteristics when a single slow axis is driven [Figure 3-25] can be approximated to a straight line. From the graph that connects the minimum and maximum drive currents with a straight line, the drive current for a given optical deflection angle can be calculated. With this method, the optical deflection angle can be controlled with an accuracy of  $1^\circ$  or less. Strictly speaking, the relationship can be approximated by a cubic polynomial function, so a cubic polynomial function must be used to control the MEMS mirror with high accuracy.

In Figure 3-25, the drive current's polarity represents the direction of the drive current flowing through the slow-

axis coil. The drive current's direction can be used to change the direction of the optical deflection angle. The drive current in one direction produces 12° of optical deflection angle, and that in both positive and negative directions produces 24°.

[Figure 3-25] Optical deflection angle vs. drive current (slow axis)

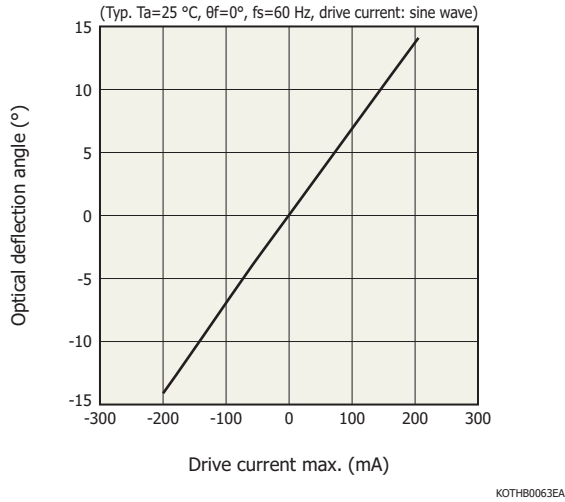

The slow-axis drive current varies depending on the optical deflection angle of the fast axis [Figure 3-26]. The change in the slow-axis drive current is small with respect to the optical deflection angle of the fast axis.

[Figure 3-26] Drive current (slow axis) vs. optical deflection angle (fast axis)

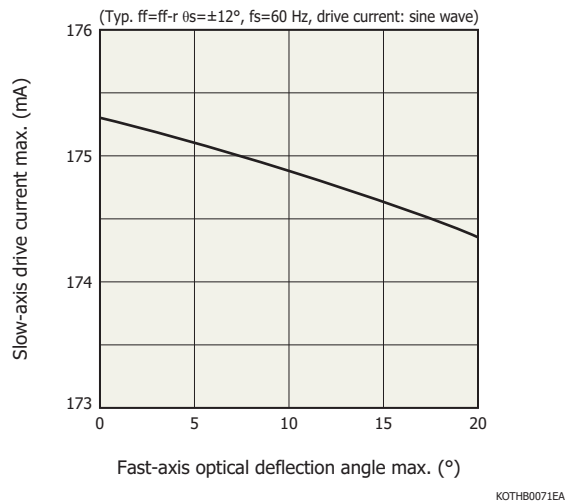

### ⚙️ Resonant frequency (slow axis)

Figure 3-27 shows the frequency characteristics of the slow axis. Since the slow axis is exclusive to linear mode, the drive frequency must be set to 100 Hz or less (solid line in Figure 3-27). The resonant frequency of the slow axis is approximately 575 Hz. If the frequency is higher than 100 Hz, the optical deflection angle will increase and moving parts may be damaged.

[Figure 3-27] Optical deflection angle vs. drive frequency (slow axis)

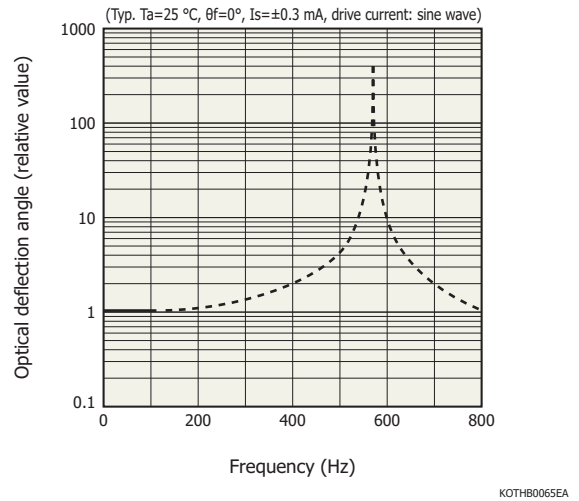

### ⚙️ Temperature characteristics

Figures 3-28 to 3-37 show the temperature characteristics when a single axis is driven for each of the fast and slow axes of the S13989-01H. The magnet's magnetic force, resonant frequency, and coil resistance have temperature characteristics. Since the magnetic force varies with temperature, the optical deflection angle and back electromotive force change.

[Figure 3-28] Temperature characteristics of optical deflection angle (fast axis)

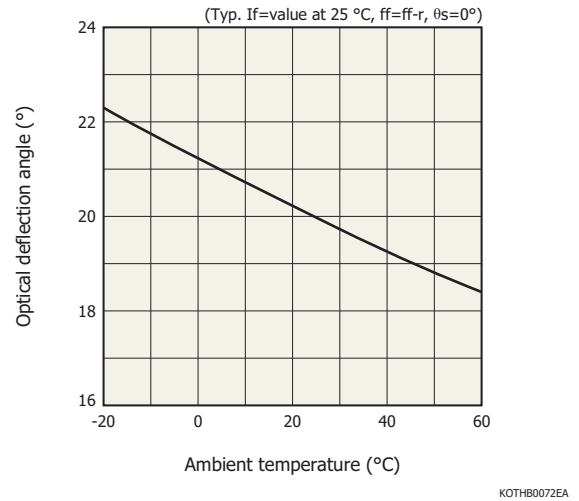

[Figure 3-29] Temperature characteristics of resonant frequency (fast axis)

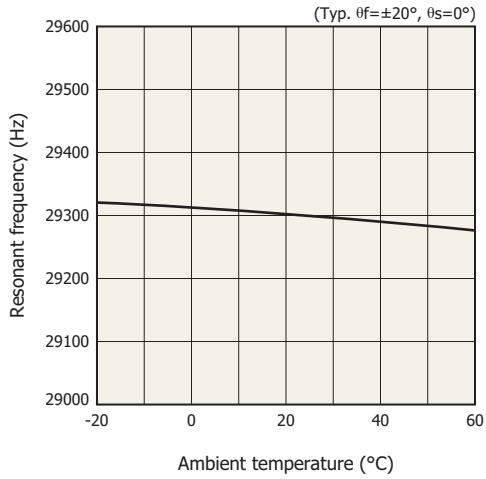

KOTH80073EA

[Figure 3-32] Temperature characteristics of coil resistance (fast axis)

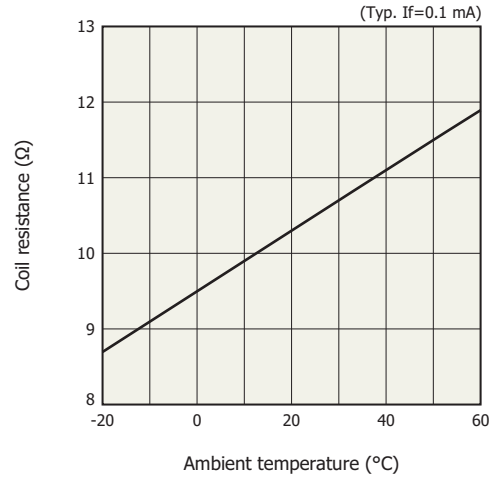

KOTH80076EA

[Figure 3-30] Temperature characteristics of back electromotive force (fast axis)

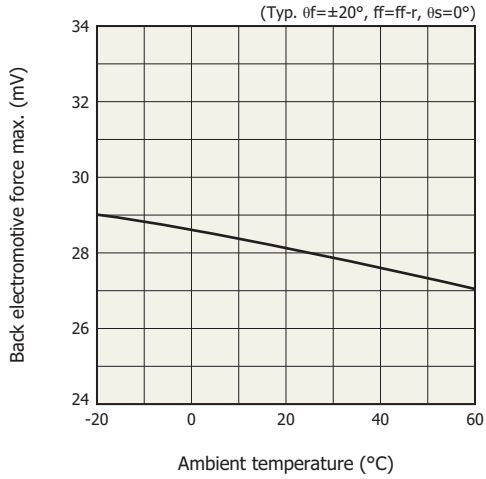

KOTH80074EA

[Figure 3-33] Temperature characteristics of optical deflection angle (slow axis)

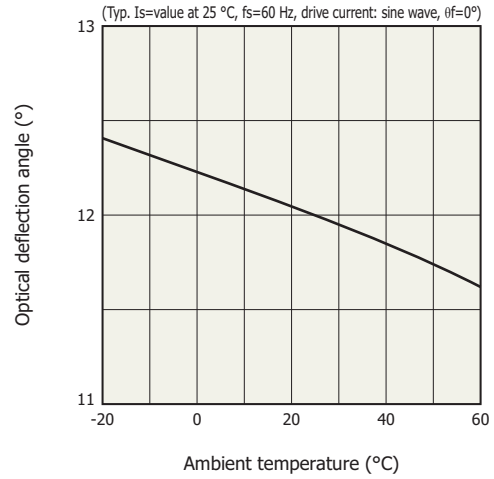

KOTH80077EA

[Figure 3-31] Temperature characteristics of slow axis's back electromotive force that occurs with fast-axis operation

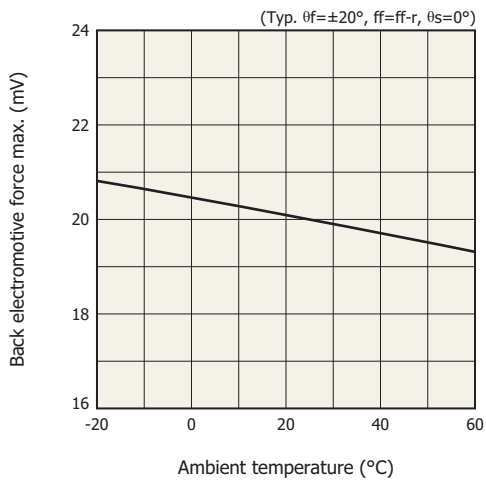

KOTH80075EA

[Figure 3-34] Temperature characteristics of resonant frequency (slow axis)

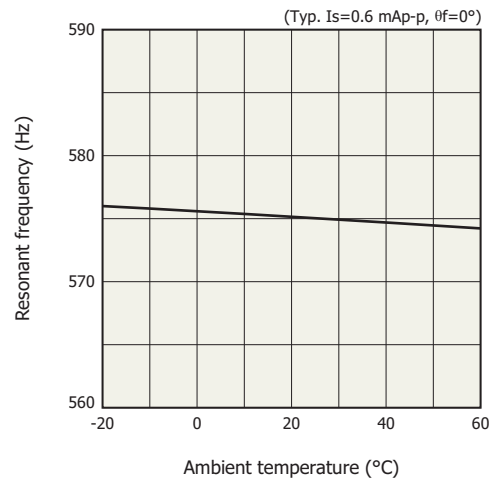

KOTH80078EA

[Figure 3-35] Temperature characteristics of Q factor (slow axis)

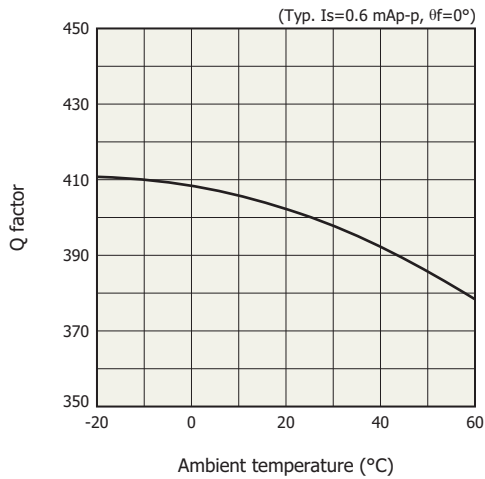

KOTHB0079EA

[Figure 3-36] Temperature characteristics of coil resistance (slow axis)

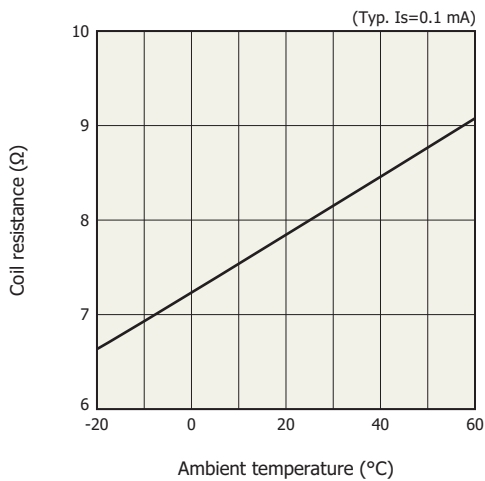

KOTHB0080EA

[Figure 3-37] Temperature characteristics of temperature sensor resistance

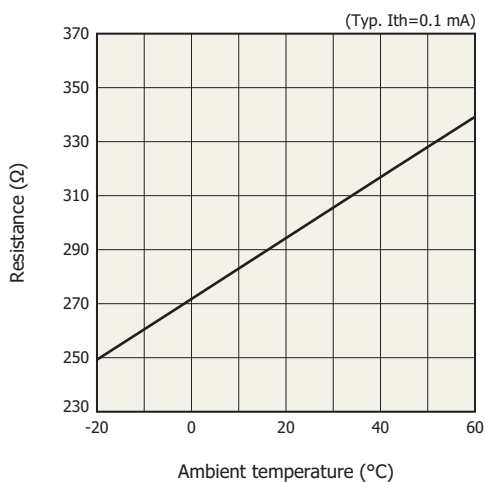

KOTHB0081EA

## 4. How to use

### 4 - 1 One-dimensional type

#### » Drive method

If a voltage source is used to control the drive current, the drive current is determined by the applied voltage and coil resistance. Coil resistance changes due to the heat generated by the drive current and ambient temperature. As such, to make a given current flow through the coil using a voltage source, you must monitor the coil resistance and adjust the voltage. To vary the optical deflection angle continuously, you must also take back electromotive force into consideration. When the MEMS mirror is operated in linear mode, the drive frequency is relatively low, so the back electromotive force is extremely small and can be ignored in some cases, but when operated in non-linear mode, it cannot be ignored in most cases. When a voltage source is used, the actual voltage applied to the coil is the voltage obtained by subtracting the back electromotive force from the applied voltage, and this makes controlling the drive current difficult. Therefore, a current source is used to drive the MEMS mirror in order to control the current flowing through the coil [Figure 4-1]. Figure 4-2 shows an example of a driver circuit.

[Figure 4-1] Drive example

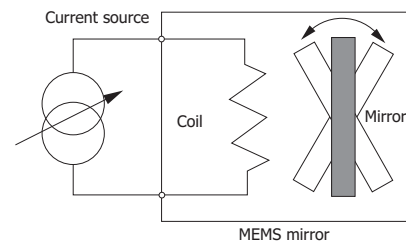

KOTHC0072EA

[Figure 4-2] Example of driver circuit

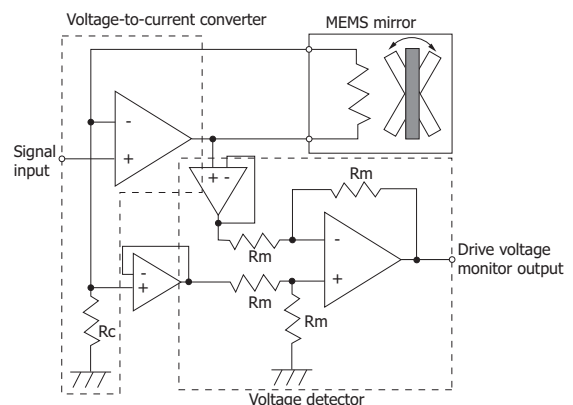

KOTHC0073EA



Driving a MEMS mirror only requires a voltage-to-current converter. Further adding a voltage detector enables the detection of back electromotive force and coil resistance. The drive current of the MEMS mirror in Figure 4-2 is expressed by equation (4-1) using input voltage  $V_s$ .

$$I_s = \frac{V_s}{R_c} \dots\dots\dots (4-1)$$

$I_s$  : drive current  
 $R_c$  : current detection resistor

Using a metal film resistor with a small temperature coefficient as a current detection resistor allows the drive current to be controlled down to 0.1% or less in the operating temperature range. The voltage detector section detects the potential difference that is actually applied across the coil terminals of the MEMS mirror and outputs it to the drive voltage monitor output terminal. The coil resistance can be determined by dividing this voltage by the drive current given by equation (4-1).

### » Mirror size and beam size

For the light source used with the MEMS mirror, we recommend a semiconductor laser (except when a specific light source is required). The optical system must be designed so that the beam size of the light source is sufficiently smaller than the mirror size. Semiconductor lasers are suited to achieve small beam sizes.

The MEMS mirror is designed so that its mirror size is maximized within the range that provides the required optical deflection angle versus drive current characteristics and frequency characteristics. For example, the diameter of the mirror in the S12237-03P is 2.6 mm. This is sufficiently large to be used in combination with semiconductor lasers and other coherent light sources in a wide range of applications. However, the mirror size may not be enough depending on the application, so it is necessary to check that the MEMS mirror can provide the required performance beforehand. When a MEMS mirror scans light, the distance from the light source to the mirror and the distance to the projection screen must be verified.

Even with a collimator lens, it is not possible to make the laser light an ideal collimated light. An ideal Gaussian beam has a divergence angle due to diffraction. The divergence half-angle  $\theta$  is expressed by equation (4-2).

$$\theta = \tan^{-1} \left( \frac{\lambda}{\pi \omega_0} \right) \dots\dots\dots (4-2)$$

$\lambda$  : wavelength of laser light [ $\mu\text{m}$ ]  
 $\omega_0$  : beam waist [ $\mu\text{m}$ ]

Beam waist is the radius of the beam at the focal point when the laser light is concentrated with an optical system. Design the optical system to maximize the beam waist to make the beam as close to a collimated light as

possible.

Figure 4-3 shows an optical system in which a 630 nm wavelength laser beam is concentrated, reflected at the mirror, and focused on a screen at distance  $L$  from the mirror. The beam size on the screen is  $S (=2\omega)$ . In this condition, check whether the beam size on the mirror surface is smaller than the mirror size.

[Figure 4-3] Optical system

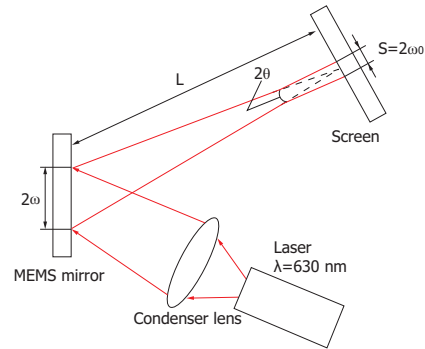

K0THC0074EA

If distance  $L$  to the screen is 100 mm, and the beam is focused on the screen at  $S = \phi 100 \mu\text{m}$ , the beam waist  $\omega_0$  is 50  $\mu\text{m}$ . When  $\lambda = 0.63 \mu\text{m}$  is substituted in equation (4-2), the beam divergence half-angle  $\theta$  is  $4 \times 10^{-3}$  [rad]. The radius of the beam at the mirror position is  $\omega = 100 \text{ mm} \times \tan(\theta) = 400 \mu\text{m}$ , and the beam size is  $\phi 800 \mu\text{m}$ . The beam size is typically defined in area at  $(1/e)^2$  the peak power, so even when the spreading of the beam is considered, the S12237-03P mirror size of  $\phi 2.6 \text{ mm}$  is sufficiently large.

If the distance  $L$  to the screen is 1 m and you want to focus the beam at  $\phi 100 \mu\text{m}$  on the screen, calculating the required mirror size in the same manner yields  $\phi 8 \text{ mm}$  or greater, and the S12237-03P mirror size is not enough to cover this diameter. However, if the beam can be focused at  $\phi 1 \text{ mm}$  on the screen, because the beam divergence angle  $\theta$  is  $4 \times 10^{-2}$  [rad], the diameter at the mirror position is 1.8 mm, and the S12237-03P mirror size can cover this diameter.

In this way, consider the required beam size and the distance between the mirror and the screen, and check whether the mirror size of the MEMS mirror is sufficient.

### » Measurement system of optical deflection angle vs. drive current characteristics

As explained in “Electrical and optical characteristics” of section 3-1, “One-dimensional type,” the optical deflection angle can be controlled down to  $1^\circ$  or less by approximating the relationship between the optical deflection angle and drive current with a straight line. Controlling the optical deflection angle at an even higher accuracy requires highly accurate measurement of the relationship between the optical deflection angle and drive current. Figure 4-4 shows an example of such a measurement system.

[Figure 4-4] Simple measurement system of optical deflection angle vs. drive current characteristics

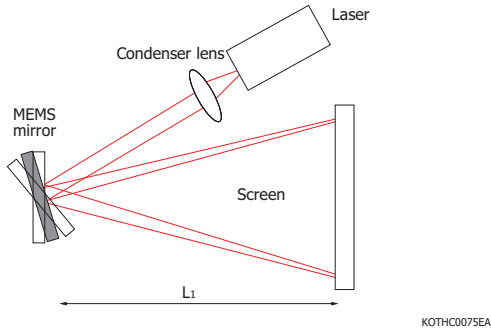

The light output from a laser device is concentrated with a condenser lens. The focus position is set on the screen surface where the mirror is directed at. The reflected light from the mirror is projected at a given position on the screen according to the mirror's optical deflection angle. This position is detected to measure the optical deflection angle.

A screen with a scale (e.g., graph paper) is used so that the projected position on the screen can be determined. If you want to detect positions at about 1 mm resolution on the screen, we recommend that the beam size be set to about 500 μm. Making the beam size too small will increase the beam size on the mirror surface due to diffraction. When the wavelength is 632 nm and the beam size 500 μm, the focusing numerical aperture (NA) is about  $8 \times 10^{-4}$ . When a collimated laser is used, it may be better to insert a beam expander before the condenser lens to widen the beam.

The relationship between the beam position P on the screen and optical deflection angle is expressed by equation (4-3).

$$P = L_1 \times \tan(\theta) \dots\dots\dots (4-3)$$

With Figure 4-4, if  $L_1=30$  cm and the projected positions on the screen are measured at 1 mm resolution, the optical deflection angle resolution is 0.2°. Making  $L_1$  longer can improve the optical deflection angle resolution. If you want to improve the optical deflection angle resolution further or obtain optical deflection angle data automatically, you need to use an optical sensor that detects projected positions [an image sensor or position sensitive detector (PSD)] in place of the screen. As the photosensitive area of optical sensors is not large, an optical system must be used to reduce the projection area.

Figure 4-5 shows a measurement system that uses a PSD for the optical sensor.

[Figure 4-5] Measurement system of optical deflection angle vs. drive current characteristics (using a PSD)

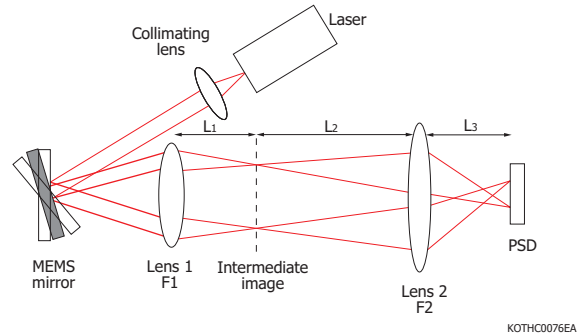

The laser beam is nearly collimated using a collimating lens. Then, the laser beam is reflected by the MEMS mirror, and the deflection angle information of the beam is converted into position information by lens 1 at the intermediate image position. Set distance  $L_1$ , from lens 1 to the intermediate image, equal to the focal distance of lens 1. The image size A at this point is expressed by equation (4-4).

$$A = 2 \times F_1 \times \tan(\theta_{max}) \dots\dots\dots (4-4)$$

$F_1$  : focal distance of lens 1  
 $\theta_{max}$ : full width at half maximum of optical deflection angle

For example, if  $F_1=30$  mm and  $\theta_{max}=15^\circ$ , image size A is 8 mm. If a PSD that can detect this size is placed at the intermediate image position and a measurement is taken, the latter stage of the optical system is not necessary. If the photosensitive area of the PSD is small, lens 2 is used to reduce the image. If the distance from the intermediate image to lens 2 is  $L_2$ , and the distance from lens 2 to the PSD is  $L_3$ , the focal distance of lens 2 must be set to  $F_2$  in equation (4-5).

$$\frac{1}{F_2} = \frac{1}{L_2} + \frac{1}{L_3} \dots\dots\dots (4-5)$$

The intermediate image in this condition is scaled by a factor of  $L_3/L_2$ , and the image is formed on the PSD. For the PSD, we recommend our C10443 series PSD module.

### » Mirror flatness and warping

The S12237-03P mirror flatness [Figure 4-6] and warping [Figure 4-7] are shown.

[Figure 4-6] Mirror flatness:  $R_a=1.3$  nm  
(S12237-03P, measurement example)

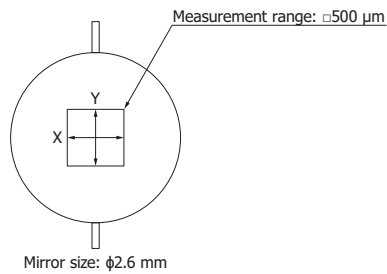
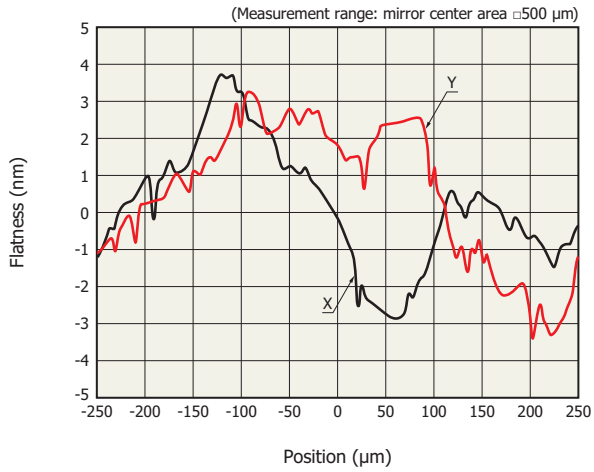

[Figure 4-7] Mirror warping  
(S12237-03P, measurement example)

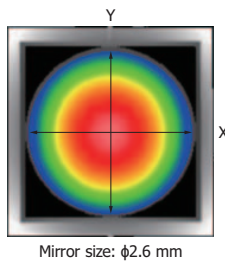
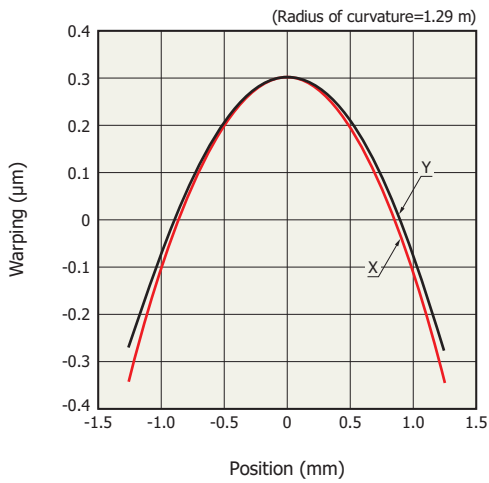

## » Magnetic field

Figure 4-9 shows the simulation data of the magnetic field of the magnet built in the S12237-03P.

[Figure 4-8] Magnetic field direction (S12237-03P)

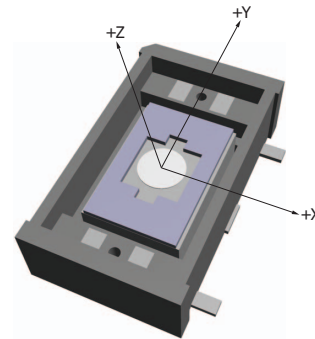

[Figure 4-9] Magnetic flux density vs. distance  
(S12237-03P, typical example)

(a) X direction

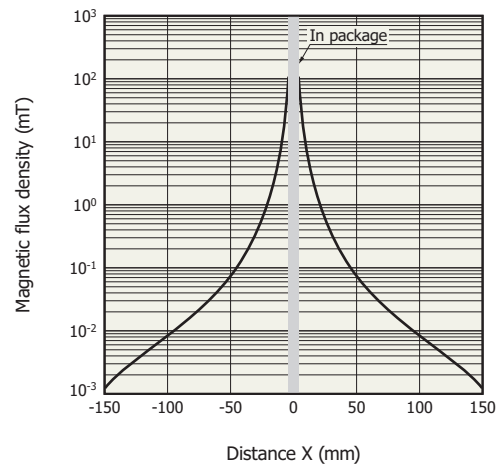

(b) Y direction

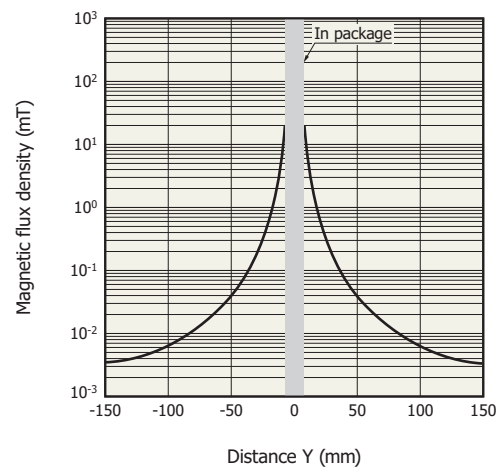

(c) Z direction

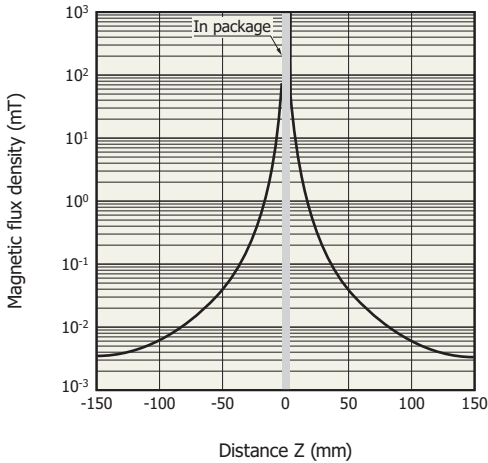

K0THB0043EA

» Reduction in magnetic force due to high temperature

The magnetic force of the magnet built in the MEMS mirror decreases when exposed to high temperatures for a long time. Reduction in magnetic force occurs due to heat and length of time when soldering the MEMS mirror, causing the characteristics (especially the current vs. optical deflection angle characteristics) to change. When soldering with a soldering iron, use a pair of tweezers or the like to prevent the product from moving. Otherwise, when the solder tip is brought closer to the product, the product may be attracted by the magnetic force and be damaged.

Table 4-1 shows the recommended soldering conditions. If you cannot provide these conditions, then grip the root of the leads you are soldering with tweezers or a similar tool to radiate heat so that heat is not easily transferred to the package. Do not perform reflow soldering.

[Table 4-1] Recommended soldering conditions

Soldering temperature	Soldering time
260 °C or less	Within 10 s

4 - 2 Two-dimensional type

» Drive method

The S13989-01H is designed so that the fast axis is driven in non-linear mode and the slow axis in linear mode. For an example of a driver circuit, see Figure 4-2. Both the fast and slow axes can be operated with this driver circuit.

⚙ Fast axis

Since the fast axis is exclusive to non-linear mode, it must

be driven at the resonant frequency. Operate with sine wave or square wave drive current.

When the drive current is a square wave, input the drive current described in the final inspection sheet to drive at the optical deflection angle ( $\pm 20^\circ$ ) given in the recommended operating conditions. On the other hand, when the drive current is a sine wave, set the drive current to  $I_f \times 4/\pi$ . Note that the fast axis lags the drive current by  $90^\circ$ .

Because the Q factor of the fast axis is very large, the resonant frequency of the fast axis varies depending on the operation time, ambient temperature, and the operating conditions of the slow axis. Feedback control is required to adjust the drive frequency to the resonant frequency, so monitor the operation of the fast axis. This is when the back electromotive force appearing in the coil is used. The back electromotive force appears as a sine wave in the fast and slow axes' coils. The back electromotive force is in phase with the drive current when the fast axis is in resonance. By monitoring the phase of the back electromotive force, you can determine whether the fast axis is in resonance.

⚙ Slow axis

The slow axis is exclusive to linear mode and operates with an arbitrary waveform drive current with a drive frequency of DC to 100 Hz. The optical deflection angle of the slow axis varies almost linearly with the drive current [Figure 3-25]. Arbitrary operation is performed with a drive current other than a sine wave, such as a triangular wave or sawtooth wave.

» Relationship between vertical resolution and frame rate in raster scanning

There is a trade-off between vertical resolution and frame rate in raster scanning. Figure 4-10 shows an illustration of raster scanning. The horizontal axis represents the fast-axis operation and the vertical axis the slow-axis operation (drive current: sawtooth wave). Figure 4-11 shows the scanned waveform of the slow axis.

The horizontal scanning time is determined by the resonant frequency of the fast axis. The vertical resolution is determined by how many times the fast axis can move back and forth while the slow axis moves. Since the resonant frequency of the fast axis is fixed, increasing the vertical resolution increases the scanning time and decreases the frame rate. If the retrace time is shortened, the frame rate will increase, but if it is shorter than the period of the slow axis's resonant frequency, ringing will occur. Table 4-2 shows the relationship between vertical resolution and frame rate.

[Figure 4-10] Illustration of raster scanning

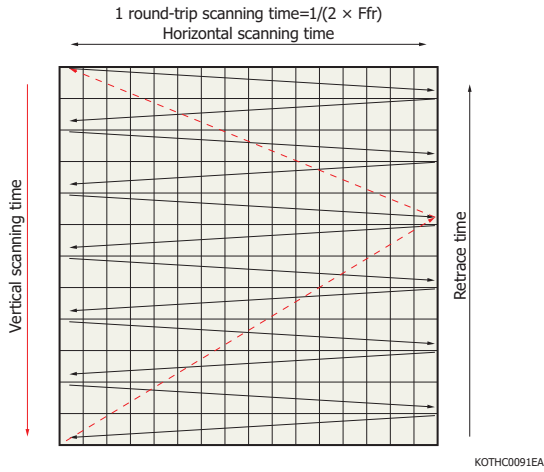

KOTH0091EA

[Figure 4-11] Mirror operation (slow axis, during raster scanning)

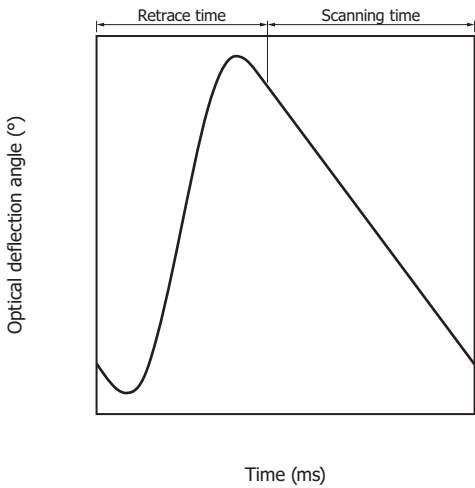

KOTH0082EA

[Table 4-2] Vertical resolution and frame rate (S13989-01H, retrace time: 1.78 ms)

Vertical resolution (unit: pixel)	256	512	720	1024	2048
Frame rate (unit: frames/s)	115	76	60	46	25

» Distortion

Figure 4-12 shows screen projection images for when the incident angle of light to the mirror is 0° and 20° in the S13989-01H. When the incident angle is 0°, the image is projected almost symmetrically, but a pincushion distortion results. On the other hand, when the incident angle is 20°, a greatly curved distortion results. In this way, the projected image's shape changes depending on the incident angle of light on the mirror. To suppress distortion, you need to install a correction optical system between the screen and MEMS mirror.

[Figure 4-12] Screen projection image

(a) Incident angle: 0°

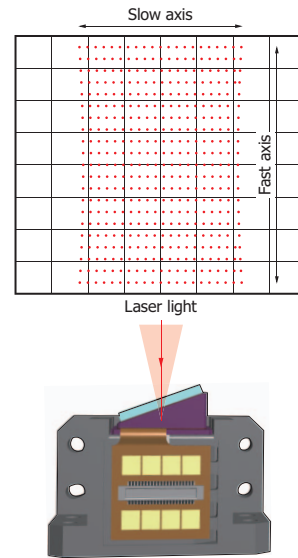

KOTH0092EA

(b) Incident angle: 20°

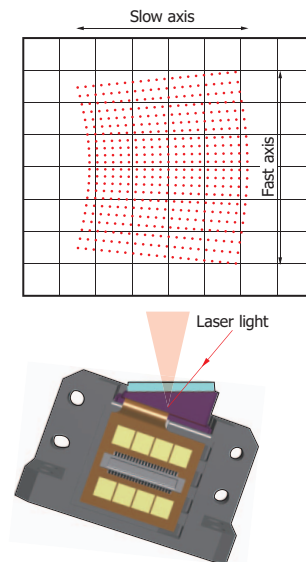

KOTH0093EA

» Magnetic field

The S13989-01H uses a magnet with a strong magnetic field. Figure 4-14 shows the simulation results of the surrounding magnetic field distribution.

[Figure 4-13] Magnetic field direction (S13989-01H)

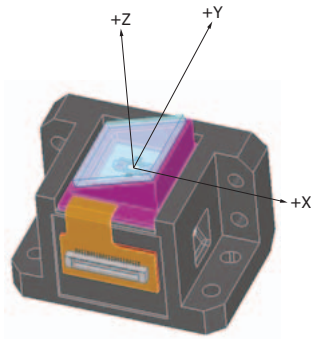

KOTHC0094EA

[Figure 4-14] Magnetic flux density vs. distance (S13989-01H, typical example)

(a) X direction

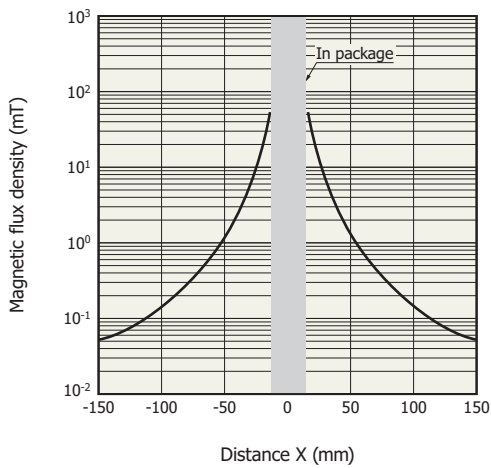

KOTHB0083EA

(b) Y direction

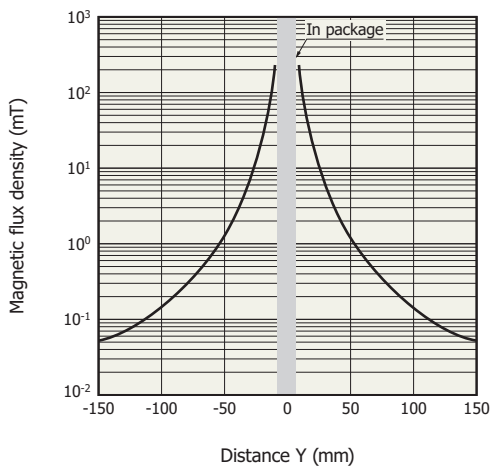

KOTHB0084EA

(c) Z direction

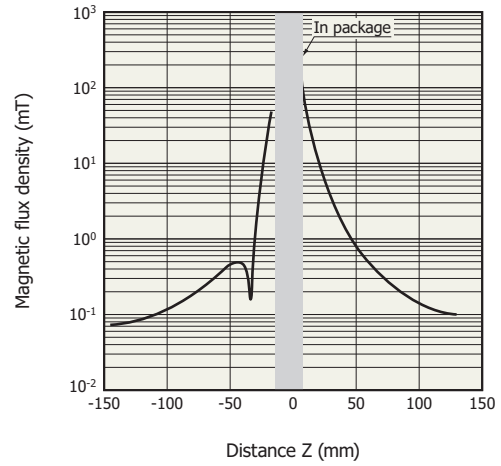

KOTHB0085EA

### » Notes when fixing the product in place

The S13989-01H has screw holes for mounting. Since it is a resin package, fastening the screws too tightly may damage the package when there is vibration. Keep the tightening torque under 0.088 N·m. A powerful magnet is inside the product. If a magnetic body is brought close to the product, the product may be damaged. We recommend using non-magnetic screws and screwdrivers when fixing the product in place.



## 5. High-accuracy control

This chapter explains the parameters that are necessary if you want to control MEMS mirrors with high accuracy. Consideration of these parameters enables the operating temperature's effects on the optical deflection angle to be corrected to some degree. If you need to control a MEMS mirror with even higher accuracy, obtain the necessary parameters in the operating conditions and feed back the values.

### 5 - 1 Correction curve for optical deflection angle vs. drive current characteristics

The optical deflection angle versus drive current characteristics of MEMS mirrors are not linear in the strict sense. Driving a MEMS mirror by assuming linearity leads to errors in the optical deflection angles. To avoid this, you need to obtain multiple sets of optical deflection angle and drive current data within the recommended operating conditions of optical deflection angles, calculate the correction curve based on the data, and use it to adjust the drive current.

Figure 5-1 shows the angle errors that appear when a correction line is created by connecting the drive currents in the recommended operating conditions of optical deflection angles ( $\pm 15^\circ$ ).

[Figure 5-1] Correction line and angle error

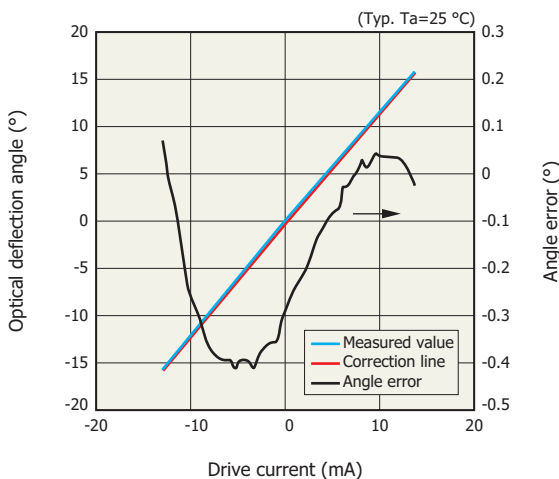

In Figure 5-1, the correction line, especially the drive current in the negative region, is shifted relative to the actual values. The maximum angle error is about  $0.4^\circ$  in the operating optical deflection angle range. Note that when differences between each device and temperature characteristics are considered, it can be assumed that the angle error of about  $\pm 1^\circ$  using this correction method is the limit.

If you want to perform correction with an even higher accuracy, you need to use a correction curve approximated with a third-order polynomial [Figure 5-2]. The angle error in Figure 5-2 is  $0.03^\circ$  or less. The resolution of this measurement system is about  $\pm 0.03^\circ$ , so this means that the angle error is corrected to about the same level. Because reproducibility of the optical deflection angle with respect to the drive current is high in MEMS mirrors, using such a correction curve to control the drive current yields highly accurate optical deflection angles.

[Figure 5-2] Third-order polynomial correction curve and angle error

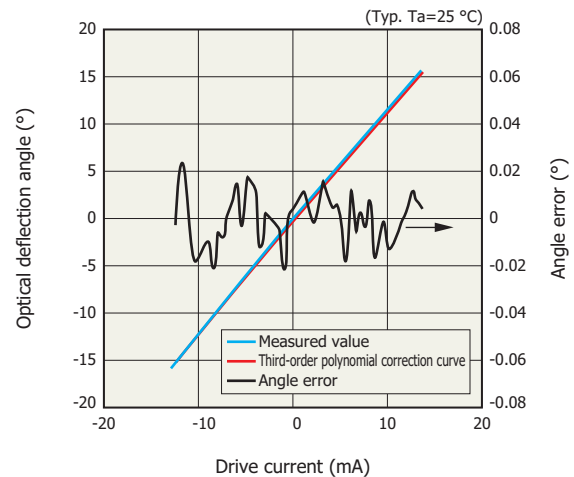

### 5 - 2 Low-speed operation and high-speed operation

There are two ways the mirror can operate while the MEMS mirror is driven: low speed and high speed. In low-speed operation, the mirror tilts slowly to a given angle and stops. In high-speed operation, the mirror can either continue to move at high speed within a given angle range or tilt quickly to a given angle and stop (step operation).

In low-speed operation, the optical deflection angle can be controlled with high accuracy by using the correction curve mentioned earlier. Further, if the absolute angle of the mirror is not very important, another way to control the angle is to obtain the drive current and drive frequency that would produce the desired mirror angle in advance and use those values in the actual operation.

#### » Frequency characteristics during high-speed operation

As MEMS mirrors are mechanical, their frequency characteristics can be expressed with an equation. This equation matches the actual operation to some degree under given operating conditions. If you want to operate the MEMS mirror (S12237-03P) at a frequency sufficiently



lower than the resonant frequency, the frequency characteristics can be expressed with equation (5-1) and equation (5-2) using parameters that can be obtained through simple measurements.

$$|T(\omega)| \cong 1 + \left(\frac{\omega}{\omega_0}\right)^2 \dots\dots\dots (5-1)$$

$$\arg\{T(\omega)\} \cong \tan^{-1} \left\{ \frac{\frac{1}{Q} \cdot \frac{\omega}{\omega_0}}{1 - \left(\frac{\omega}{\omega_0}\right)^2} \right\} \dots\dots\dots (5-2)$$

$$T(\omega) = \frac{\theta_{ac}(\omega)}{\theta_{dc}(\omega)} \dots\dots\dots (5-3)$$

$$Q = \frac{\omega_0}{\omega_2 - \omega_1} \dots\dots\dots (5-4)$$

- T(ω): transfer function
- ω<sub>0</sub> : resonant frequency
- θ<sub>dc</sub> : optical deflection angle of low-speed operation
- θ<sub>ac</sub> : optical deflection angle of high-speed operation
- Q : Q factor
- ω<sub>1</sub> : drive frequency at 1/√2 of the optical deflection angle when resonating on the low frequency side
- ω<sub>2</sub> : drive frequency at 1/√2 of the optical deflection angle when resonating on the high frequency side of the resonant frequency

Equation (5-1) expresses the absolute value of the transfer function, and equation (5-2) the phase lag of the optical deflection angle. These are parameters that can all be measured and can be obtained by using a measurement system shown in "[Figure 4-4] Simple measurement system of optical deflection angle vs. drive current characteristics." Note that equation (5-1) and equation (5-2) are for average Q factors (several tens) within the S12237-03P's recommended operating drive frequency conditions of DC to 100 Hz.

### 5 - 3 Linear mode

#### » Frequency range

Figure 5-3 shows the frequency characteristics calculated with equation (5-1) and equation (5-2) [ω<sub>0</sub>=approx. 530 Hz, Q=30 (typical S12237-03P value)]. The recommended operating optical deflection angle of 15° is used as the reference. The optical deflection angle at a drive frequency of 50 Hz (about one-tenth the resonant frequency) or less is 15° ± 0.2°. Within the recommended operating conditions of the optical deflection angle, the angle error is 0.2° or less. At 100 Hz (about one-fifth the resonant frequency) or less, the angle error is 0.6° or less. If you need an angle error of 0.5° or less for the accuracy, a drive frequency of 50 Hz or less is recommended. If you need 1° or less for the accuracy, 100 Hz or less is recommended.

[Figure 5-3] Frequency characteristics (S12237-03P)

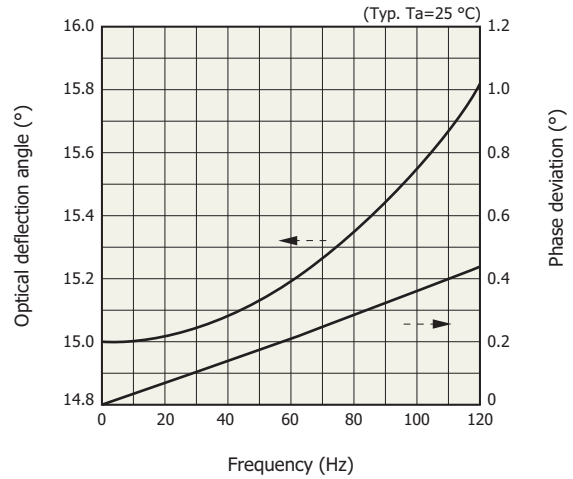

KOTH80028EA

At a drive frequency of 100 Hz or less, the phase lag is 0.4° or less, and this can be ignored in many applications. Even in linear mode, angle error occurs according to the drive frequency, so the amplitude must be kept in mind. Note that operating at a frequency higher than the recommended drive frequency range may cause damage, so use it within the recommended operating conditions.

#### » How to use linear mode

As explained earlier, in linear mode, using a drive frequency within the recommended operating conditions (1/10 to 1/5 the resonant frequency) yields excellent linearity in the optical deflection angle versus drive frequency characteristics. As such, we recommend that the drive signal's frequency components be set within the recommended operating conditions of the drive frequency.

In step operation where the mirror is tilted to a given optical deflection angle and stopped, generating a rising drive signal within the recommended operating conditions of the drive frequency causes the rising of the drive signal to be extremely slow. This may not suffice depending on the application.

The step signal and periodic waveform responses to achieve faster step operation are explained in the following sections.

#### » Step signal response

This section explains the behavior of the mirror when a step signal with a rising slope is applied [Figure 5-4].

[Figure 5-4] Step signal

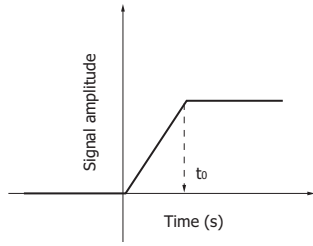

KOTH007EA

The step signal contains numerous high frequency components. If the resonant frequency component is included, ringing occurs at that frequency, and settling to a given optical deflection angle takes time. There are two methods to not include the resonant frequency component. One is to set the rise time  $t_0$  to an extremely large value, and the other is to set  $t_0$  to an integer multiple of the resonant frequency's reciprocal. In the latter, if  $t_0$  deviates from an integer multiple of the resonant frequency's reciprocal, ringing will occur, so it is important to set  $t_0$  as close to that value as possible. Using these methods will eliminate most of the resonant frequency component from the step signal. However, it cannot be eliminated completely, so some ringing will occur. This ringing is extremely small, so it will converge to a given optical deflection angle in a short wait time. Figure 5-5 shows the relationship between the ringing attenuation ratio and attenuation time for a resonant frequency of 500 Hz and  $Q=30$ .

[Figure 5-5] Ringing attenuation ratio vs. attenuation time

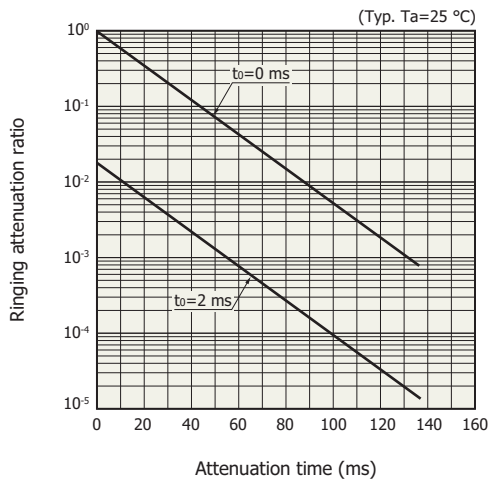

KOTH0029EA

If you want to make the attenuation ratio be 1/100, the attenuation time is 87 ms when  $t_0=0$  ms and 10 ms when  $t_0=2$  ms (the resonant frequency's period). For example, when varying the optical deflection angle from  $0^\circ$  to  $10^\circ$ , the step signal is raised in  $t_0=2$  ms, and 8 ms later, the optical deflection angle stabilizes within  $10^\circ \pm 0.1^\circ$ . To change the angle every  $1^\circ$ , the angle can be controlled with an accuracy within about  $\pm 0.1^\circ$  only with a rise time of 2 ms.

Figures 5-6 and 5-7 show the step signal's monitored response using the S12237-03P.

[Figure 5-6] Step signal response ( $t_0=0$  ms, typical example)

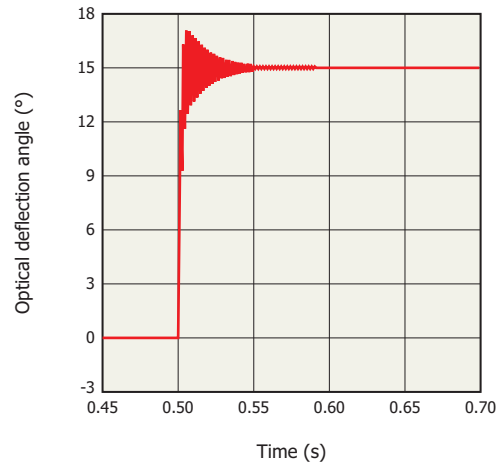

KOTH0030EA

[Figure 5-7] Step signal response ( $t_0=2$  ms, typical example)

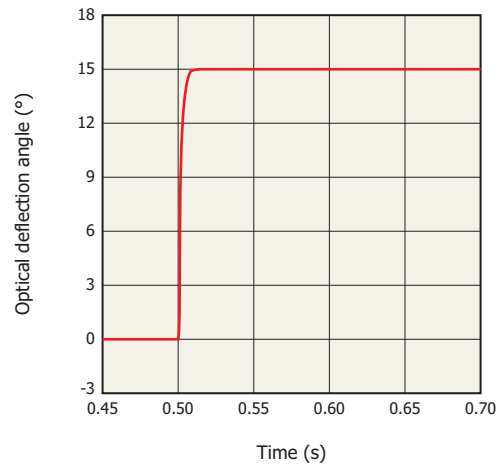

KOTH0031EA

## » Periodic waveform response

Like the step signal, the response when a periodic waveform is applied can also be optimized by not including the resonant frequency component in the drive signal and further reducing the frequency components near it.

The frequency components of a given periodic waveform can be determined through Fourier series expansion. If the input signal is divided into its frequency components and they contain the resonant frequency component and frequency components near it, the input signal parameters need to be adjusted.

### (1) Square wave

This section explains the case for a square wave (duty ratio: 50%, with the same rise time and fall time) [Figure

5-8]. In this case,  $t_2 - t_1 = t_0$  and  $t_1 = T/2$ , so there are two independent parameters:  $t_0$  and  $T$ . Setting this square wave's period to a value that is not an integer multiple of the resonant frequency's period will exclude the resonant frequency from the square wave's frequency components. However, frequency components near the resonant frequency may be included, and these components' effects must be reduced as much as possible. Therefore,  $t_0$  is set to the period of the resonant frequency (or a frequency near it).

[Figure 5-8] Square wave (duty ratio: 50%)

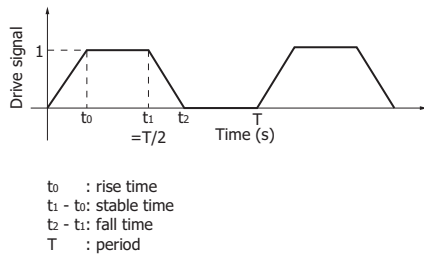

KOTH0078EA

Figures 5-9 ( $t_0=1$  ms) and 5-10 ( $t_0=2$  ms) show the monitored results of square wave responses using the S12237-03P (resonant frequency: 530 Hz). Ringing can be seen at  $t_0=1$  ms, but at 2 ms, which is near the period of the resonant frequency, ringing is suppressed. Note that  $t_0$  does not exactly match the period of the resonant frequency. In some cases, it is better that they match exactly, but in other cases, it is better that they are slightly offset. This depends on the relationship between the drive period of the square wave and the resonant frequency.

[Figure 5-9] Square wave response ( $t_0=1$  ms, typical example)

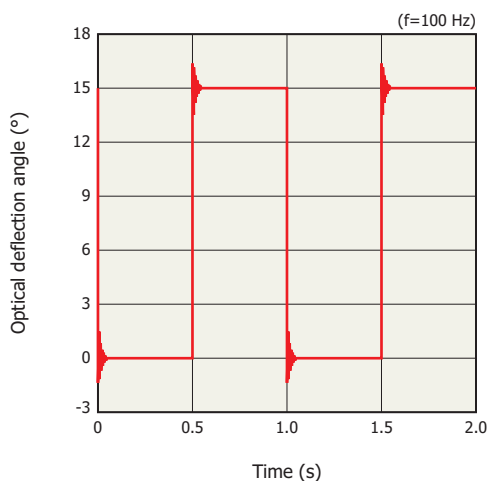

KOTH0032EA

[Figure 5-10] Square wave response ( $t_0=2$  ms, typical example)

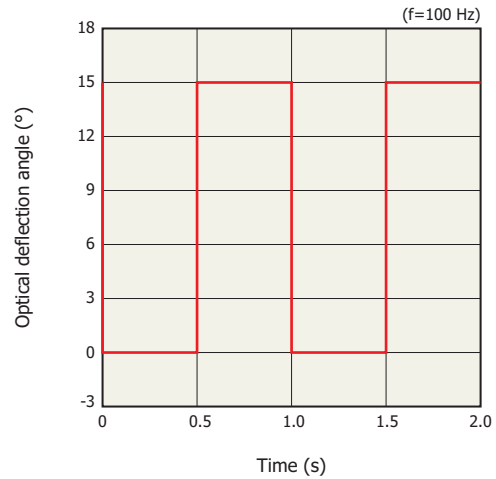

KOTH0033EA

## (2) Sawtooth wave

A sawtooth wave [Figure 5-11] can be obtained by converting  $t_0$ ,  $t_1$ , and  $t_2$  of the square wave in Figure 5-8 and can basically be handled in the same manner as the square wave. A sawtooth wave is obtained when  $t_1=t_0$  and  $t_2=T$  (there are two parameters in this case). For a sawtooth wave, ringing can be minimized in the same manner as the square wave by following the procedure below.

- ① Set the period to a value that is not an integer multiple of the resonant frequency's period
- ② Set the rise time  $t_0$  to an integer multiple of the resonant frequency's period

[Figure 5-11] Sawtooth wave

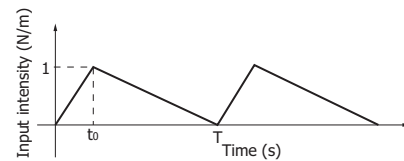

KOTH0079EA

Figure 5-12 shows the changes in the optical deflection angle when a sawtooth wave (period: 30 Hz) is applied to an S12237-03P (resonant frequency: 500 Hz). The rise time of the drive signal is set to about 4 ms, which is double the resonant frequency's period. In Figure 5-12, a clean response is obtained for the sawtooth wave. Note that the distortion in the response during the rise time cannot be suppressed. Use the response of the falling slope.

[Figure 5-12] Sawtooth wave response  
( $t_0=4$  ms, typical example)

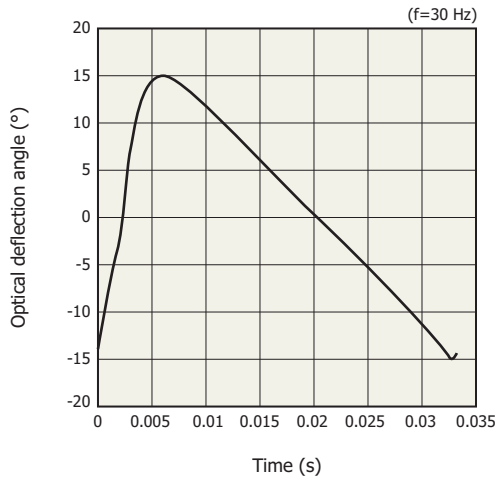

KOTH80034EA

## 5 - 4 Ringing correction

Since the MEMS mirror is mechanical, it has a resonant frequency. When driving the MEMS mirror in linear mode, set the drive frequency to 1/5 or less of the resonant frequency to avoid ringing (S12237-03P: 100 Hz or less). Even when the drive frequency is 1/5 or less of the resonant frequency, ringing will occur if the drive current contains frequency components that induce MEMS mirror resonance. Ringing can be suppressed by removing frequency components that induce MEMS mirror resonance from the drive current in advance.

Figure 5-13 shows ringing correction. If the drive current indicated in (a) (the same waveform as the ideal optical deflection angle waveform) is input to the MEMS mirror in linear mode, the optical deflection angle should ideally be the black line indicated in (b). But, actually, ringing occurs as shown by the red line.

The black line in (c) shows the ideal waveform of the optical deflection angle in (b) with the frequency on the horizontal axis. The red line in (c) shows the ideal drive frequency waveform of the MEMS mirror. There are frequency components of the ideal optical deflection angle waveform near the resonant frequency. Therefore, when a drive current with the ideal optical deflection angle waveform is input to the MEMS mirror, frequency components near the resonant frequency are amplified and ringing occurs [red line in (d)].

Ringing can be suppressed by reducing the frequency components near the resonant frequency from the drive current with the ideal optical deflection angle waveform [red line in (e)]. When the drive current with these frequency characteristics is converted into the time domain, it becomes as shown in (f). When this drive current is input to the MEMS mirror, the ideal optical deflection angle waveform shown in (b) can be achieved.

[Figure 5-13] Ringing correction

(a) Drive current vs. time  
(same waveform as the ideal optical deflection angle waveform)

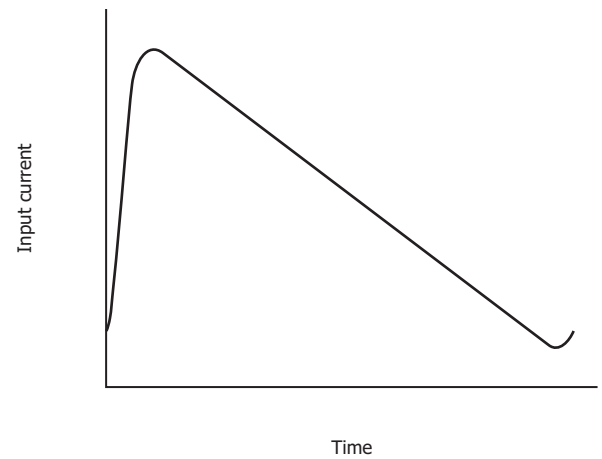

KOTH80044EA

(b) Optical deflection angle vs. time  
[when drive current (same waveform as the ideal optical deflection angle waveform) is input]

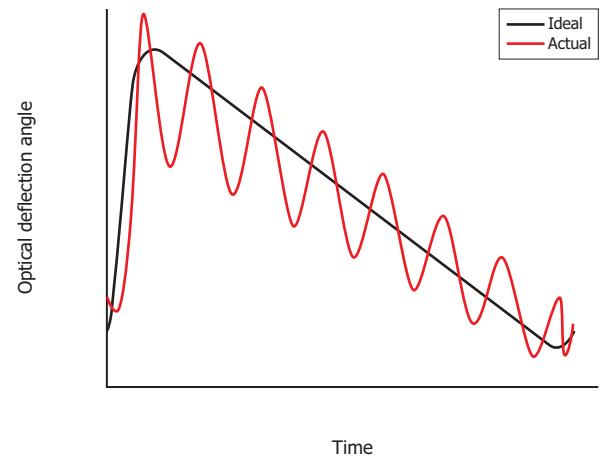

KOTH80045EA

(c) Ideal drive frequency waveform and frequency components

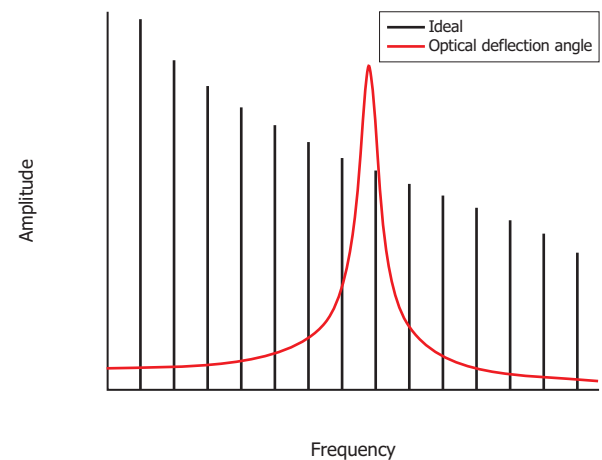

KOTH80046EA

(d) Drive frequency components

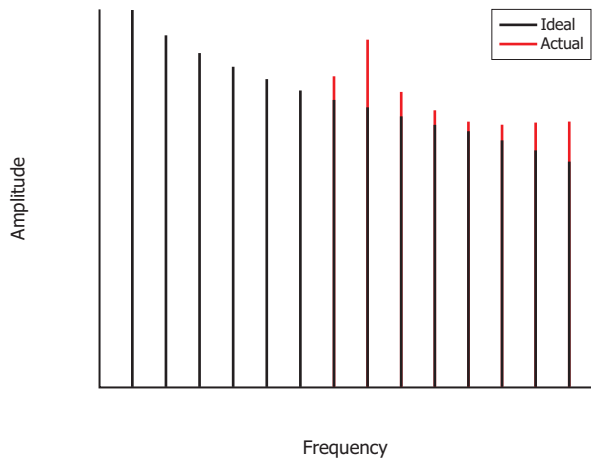

KOTHB0047EA

(e) Drive frequency components (before and after ringing correction)

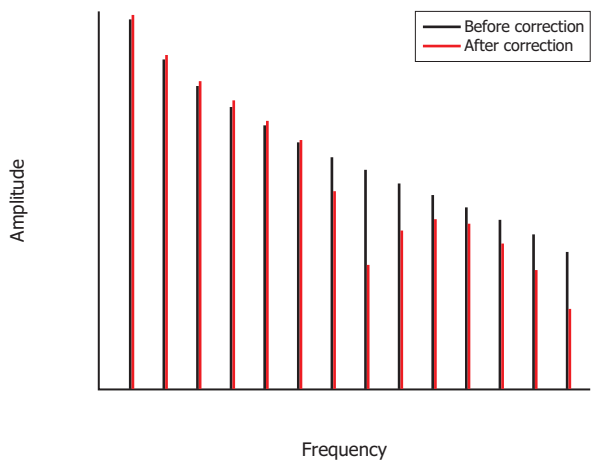

KOTHB0048EA

(f) Drive current vs. time (after ringing correction)

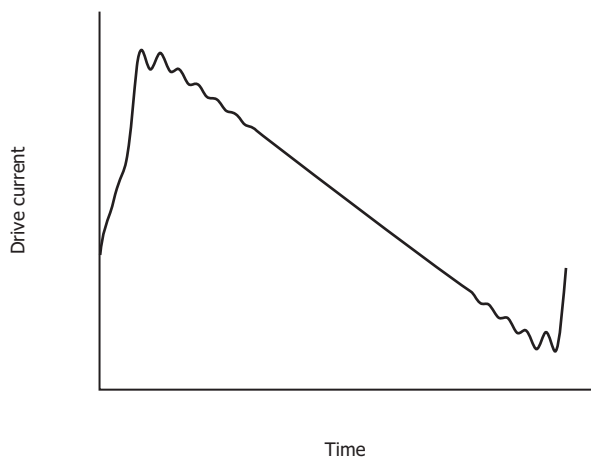

KOTHB0049EA

Figure 5-14 shows the effect of ringing correction. Figure 5-14 (a) is the result obtained by inputting the same drive current as the ideal optical deflection angle waveform. There is an error of about  $\pm 1^\circ$  at the falling edge with respect to the ideal optical deflection angle. In addition, Figure 5-14 (b) shows the result obtained by inputting a drive current with ringing correction. The error is

suppressed to  $\pm 0.03^\circ$  or less at the falling edge with respect to the ideal optical deflection angle waveform. Note that the accuracy of this optical deflection angle measurement system is  $\pm 0.03^\circ$ , and ringing is suppressed to that level.

In Figure 5-14 (b), the error is measured from (a) and reflected in the ringing correction to match the actual frequency characteristics of the optical deflection angle. This operation can be repeated multiple times [Figure 5-14 (b): 4 times] to remove frequency components that could not be filtered and further reduce ringing.

[Figure 5-14] Effect of ringing correction (measurement example)

(a) Before ringing correction

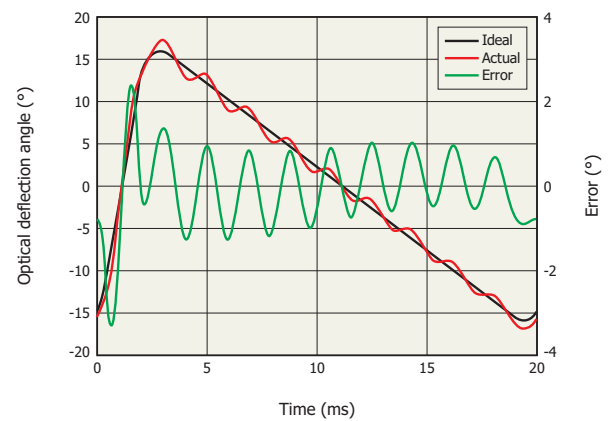

KOTHB0050EA

(b) After ringing correction

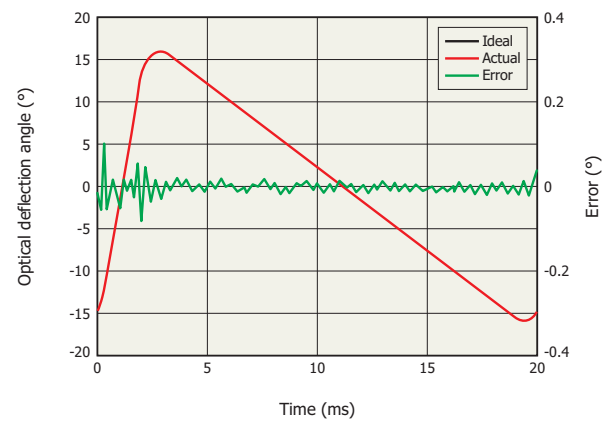

KOTHB0051EA

## 5 - 5 Temperature correction

The electromagnetic MEMS mirror moves its mirror by generating Lorentz force using the magnetic field of the magnet and the current flowing through the coil. The optical deflection angle decreases as the ambient temperature increases, so the drive current must be increased [Figure 3-9]. The drive current's temperature characteristics depend on the temperature characteristics of the magnetic force. The magnet's magnetic force decreases as the ambient temperature increases.

Therefore, to keep the optical deflection angle constant when the ambient temperature changes, you need to monitor the temperature and correct the drive current. A temperature sensor must be installed as close to the MEMS mirror as possible in the enclosure or on the circuit board that the MEMS mirror is mounted on. Table 5-1 shows the temperature coefficient of the S12237-03P MEMS mirror's optical deflection angle.

[Table 5-1] Temperature coefficient of optical deflection angle

(S12237-03P, linear value,  $\theta_s = \pm 15^\circ$ , typical value)

Temperature range	Temperature coefficient $\alpha$ Typ.
-20 to +70 °C	-0.095%/°C
-20 to +25 °C	-0.085%/°C
+25 to +70 °C	-0.105%/°C

The temperature coefficient  $\alpha$  of the optical deflection angle in Table 5-1 is the value when the drive current is constant and is expressed by equation (5-5).

$$\alpha = \frac{\theta_s(I_s, T_2) - \theta_s(I_s, T_1)}{T_2 - T_1} \times 100 \dots\dots\dots (5-5)$$

$T_1$  to  $T_2$ : temperature range  
 $\theta_s(I, T)$ : optical deflection angle (I: drive current, T: temperature)

As shown in Table 5-1, the temperature coefficient of the optical deflection angle is different between the -20 to +25 °C range and the +25 to +70 °C range and is non-linear. To perform temperature correction with high accuracy, you need to calculate the temperature coefficient of the optical deflection angle using the quadratic polynomial in equation (5-6). Table 5-2 shows the correction factor of the quadratic polynomial.

$$\beta = 1 + \alpha_1 \cdot \Delta T + \alpha_2 \cdot \Delta T^2 \dots\dots\dots (5-6)$$

$\Delta T$  : T - Tstd  
 T : ambient temperature  
 Tstd: reference temperature (25 °C)

[Table 5-2] Quadratic polynomial correction factor for temperature coefficient of optical deflection angle

(S12237-03P, typical value)

Correction coefficient	Value
$\alpha_1$	$-9.4 \times 10^{-4}$
$\alpha_2$	$-1.81 \times 10^{-6}$

In actual temperature correction, the drive current is divided by  $\beta$  to keep the optical deflection angle constant. When  $\alpha$  of Table 5-1 is substituted into  $\alpha_1$  of equation (5-6) and 0 is substituted into  $\alpha_2$  of equation (5-6),  $\beta$  is obtained.

Figure 5-15 shows the result of applying temperature correction using the drive current as described above and ringing correction (see "5-4 Ringing correction"). Even at an ambient temperature of 70 °C, operation equivalent to that in room temperature can be achieved with only a drive current correction.

[Figure 5-15] Temperature correction results (with ringing correction, measurement example)

(a) Tcase=25 °C

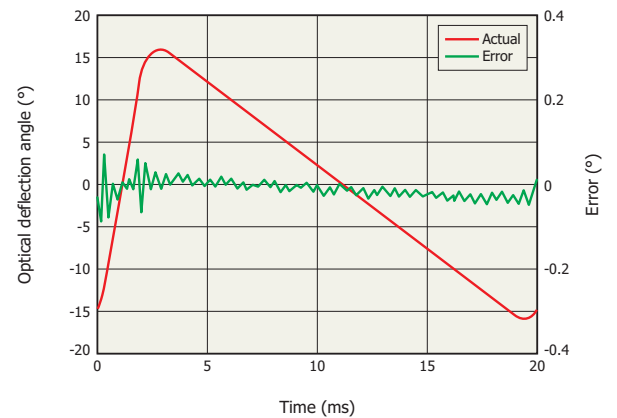

KOTH80052EA

(b) Tcase=-20 °C

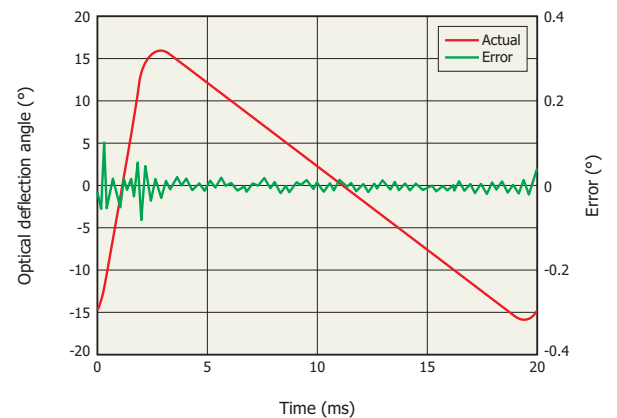

KOTH80053EA

(c) Tcase=70 °C

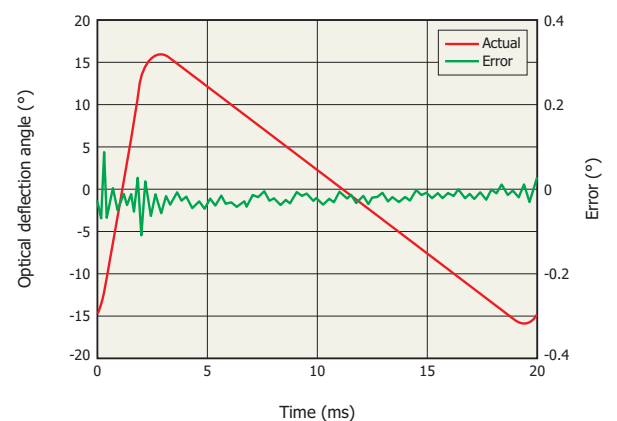

KOTH80054EA

## 5 - 6 Reproducibility of optical deflection angle

Figure 5-17 shows examples of reproducibility over time for A to D in Figure 5-16. These data show the amount of change in the optical deflection angle when the MEMS mirror is operated for 30 minutes and show that the stability is  $\pm 0.01$  degrees or less.

[Figure 5-16] Optical deflection angle vs. time

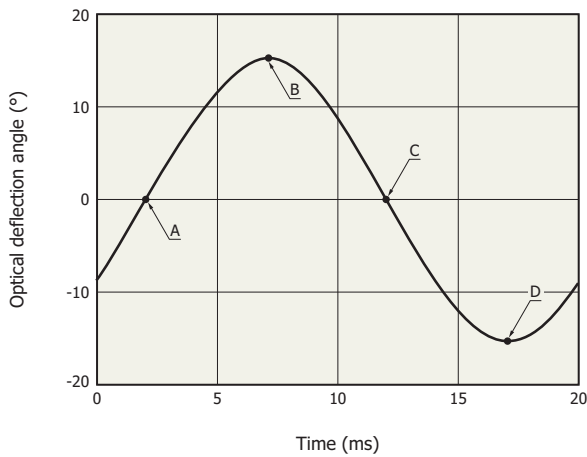

<Measurement conditions>

- Drive waveform: sine wave
- Drive frequency: 50 Hz
- Drive current amplitude: 15 mA
- Measurement time: 30 min
- Measurement interval: 1 s
- Measurement accuracy of the measurement device:  $\pm 0.03^\circ$

KOTHB0055EA

[Figure 5-17] Examples of optical deflection angle's reproducibility

(a) Near A

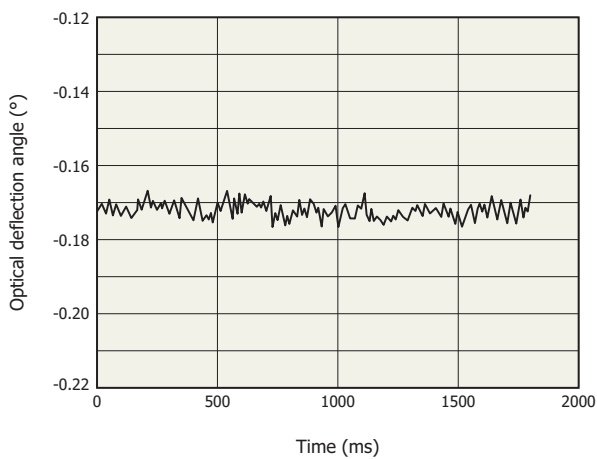

KOTHB0056EA

(b) Near B

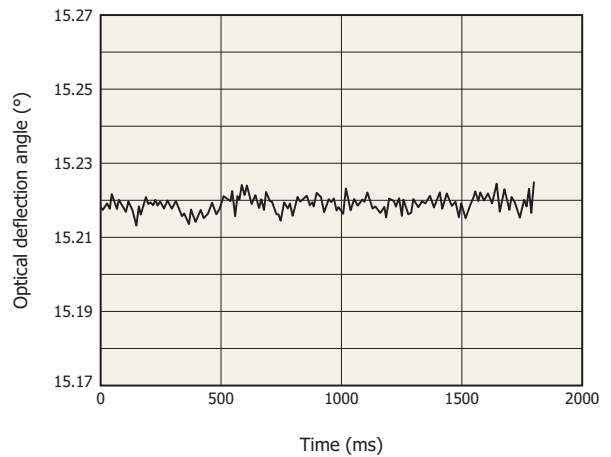

KOTHB0057EA

(c) Near C

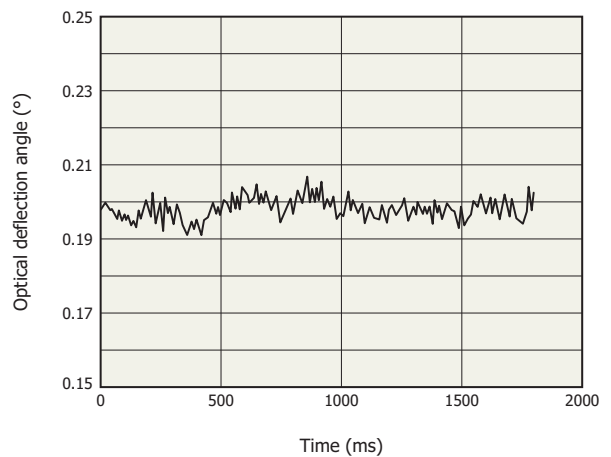

KOTHB0058EA

(d) Near D

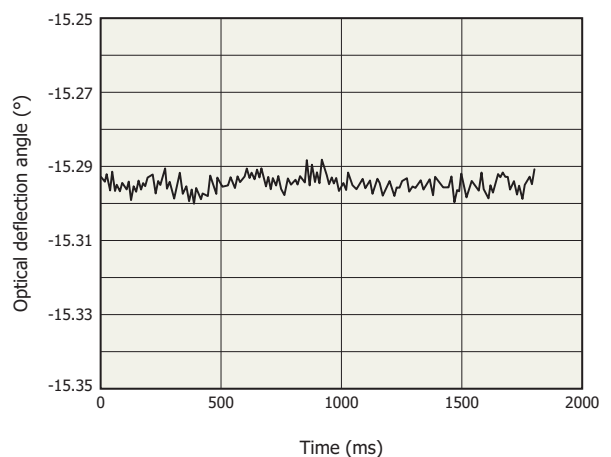

KOTHB0059EA



Information described in this material is current as of February 2020.

Product specifications are subject to change without prior notice due to improvements or other reasons. This document has been carefully prepared and the information contained is believed to be accurate. In rare cases, however, there may be inaccuracies such as text errors. Before using these products, always contact us for the delivery specification sheet to check the latest specifications.

The product warranty is valid for one year after delivery and is limited to product repair or replacement for defects discovered and reported to us within that one year period. However, even if within the warranty period we accept absolutely no liability for any loss caused by natural disasters or improper product use. Copying or reprinting the contents described in this material in whole or in part is prohibited without our prior permission.

# HAMAMATSU

[www.hamamatsu.com](http://www.hamamatsu.com)

HAMAMATSU PHOTONICS K.K., Solid State Division

1126-1 Ichino-cho, Higashi-ku, Hamamatsu City, 435-8558 Japan, Telephone: (81)53-434-3311, Fax: (81)53-434-5184

U.S.A.: Hamamatsu Corporation: 360 Foothill Road, Bridgewater, N.J. 08807, U.S.A., Telephone: (1)908-231-0960, Fax: (1)908-231-1218, E-mail: [usa@hamamatsu.com](mailto:usa@hamamatsu.com)

Germany: Hamamatsu Photonics Deutschland GmbH: Arzbergerstr. 10, D-82211 Herrsching am Ammersee, Germany, Telephone: (49)8152-375-0, Fax: (49)8152-265-8, E-mail: [info@hamamatsu.de](mailto:info@hamamatsu.de)

France: Hamamatsu Photonics France S.A.R.L.: 19, Rue du Saule Trapu, Parc du Moulin de Massy, 91882 Massy Cedex, France, Telephone: (33)1 69 53 71 00, Fax: (33)1 69 53 71 10, E-mail: [infos@hamamatsu.fr](mailto:infos@hamamatsu.fr)

United Kingdom: Hamamatsu Photonics UK Limited: 2 Howard Court, 10 Tewin Road, Welwyn Garden City, Hertfordshire AL7 1BW, United Kingdom, Telephone: (44)1707-294888, Fax: (44)1707-325777, E-mail: [info@hamamatsu.co.uk](mailto:info@hamamatsu.co.uk)

North Europe: Hamamatsu Photonics Norden AB: Torshamnsgatan 35 16440 Kista, Sweden, Telephone: (46)8-509 031 00, Fax: (46)8-509 031 01, E-mail: [info@hamamatsu.se](mailto:info@hamamatsu.se)

Italy: Hamamatsu Photonics Italia S.r.l.: Strada della Moia, 1 int. 6, 20020 Arese (Milano), Italy, Telephone: (39)02-93 58 17 33, Fax: (39)02-93 58 17 41, E-mail: [info@hamamatsu.it](mailto:info@hamamatsu.it)

China: Hamamatsu Photonics (China) Co., Ltd.: B1201, Jiaming Center, No.27 Dongsanhuan Beilu, Chaoyang District, 100020 Beijing, P.R.China, Telephone: (86)10-6586-6006, Fax: (86)10-6586-2866, E-mail: [hpc@hamamatsu.com.cn](mailto:hpc@hamamatsu.com.cn)

Taiwan: Hamamatsu Photonics Taiwan Co., Ltd.: 8F-3, No. 158, Section2, Gongdao 5th Road, East District, Hsinchu, 300, Taiwan R.O.C. Telephone: (886)3-659-0080, Fax: (886)3-659-0081, E-mail: [info@hamamatsu.com.tw](mailto:info@hamamatsu.com.tw)