

# Balanced detectors



C12668 series

## Balanced detectors with reduced multiple reflections

These are differential amplification type photoelectric conversion modules containing two Hamamatsu photodiodes with balanced characteristics. The photodiodes are connected in a direction that cancels out the photocurrent of each photodiode. This configuration cancels out the common mode noise of the two incident light rays. The minute difference in light levels is treated as a displacement signal, converted into an electrical signal, and output. Moreover, the adoption of our unique structure that suppresses multiple reflections of incident light has made it possible to reduce the noise caused by the reflections. These products can be applied to optical coherence tomography (OCT) used in ophthalmologic examinations and the like. The balanced detector can convert into electrical signals the minute difference in the signal light produced when the back scattering light from the subject is made to interfere with the reference light.

### Features

- Employs our unique (patented) structure that reduces multiple reflections at the incident light wavelength of 1.0  $\mu\text{m}$  or 1.3  $\mu\text{m}$  (-01, -02, -03, -04)
- Cutoff frequency:  
200 MHz (-01, -02), 400 MHz (-03, -04), 800 MHz (-05, -06)
- Common-mode rejection ratio (CMRR: Common-Mode Rejection Ratio):  
35 dB typ. (-01, -02), 30 dB typ. (-03, -04, -05, -06)
- Input section: FC receptacle (APC polished)  
A single-mode fiber with an FC connector can be connected.
- Output section: SMA receptacle
- Compact

### Application

- OCT

### Structure

| Type no.             | Built-in element      | Dimensions (mm) | Weight (g)   | Input section                | Output section |
|----------------------|-----------------------|-----------------|--------------|------------------------------|----------------|
| C12668-01            | InGaAs PIN photodiode | 25 × 54.5 × 65  | 168          | FC receptacle (APC polished) | SMA receptacle |
| C12668-02            |                       |                 | 190          |                              |                |
| C12668-03            |                       | 25 × 78 × 72    | 115          |                              |                |
| C12668-04            |                       |                 | 18 × 63 × 70 |                              |                |
| <b>NEW</b> C12668-05 |                       |                 |              |                              |                |
| <b>NEW</b> C12668-06 |                       |                 |              |                              |                |

### ➤ Absolute maximum ratings (Ta=25 °C, unless otherwise noted)

| Type no.             | Supply voltage<br>(V) | Incident light level<br>$\lambda=1.55 \mu\text{m}$<br>(mW) | Operating temperature*1<br>(°C) | Storage temperature*1<br>(°C) |
|----------------------|-----------------------|--|---------------------------------|-------------------------------|
| C12668-01            | ±17                   | 5  | 0 to +50                        | -10 to +60                    |
| C12668-02            |                       | 4.5  |                                 |                               |
| C12668-03            |                       | 5  |                                 |                               |
| C12668-04            |                       | 4.5  |                                 |                               |
| <b>NEW</b> C12668-05 | ±13.5                 | 5  |                                 |                               |
| <b>NEW</b> C12668-06 |                       | 4.5  |                                 |                               |

\*1: No dew condensation

When there is a temperature difference between a product and the surrounding area in high humidity environments, dew condensation may occur on the product surface. Dew condensation on the product may cause deterioration in characteristics and reliability.

Note: Exceeding the absolute maximum ratings even momentarily may cause a drop in product quality. Always be sure to use the product within the absolute maximum ratings.

### ➤ Recommended operating conditions (Ta=25 °C)

| Type no.             | Supply voltage*2<br>Vs<br>(V) |      |       |
|----------------------|-------------------------------|------|-------|
|                      | Min.                          | Typ. | Max.  |
| C12668-01            | ±11                           | ±12  | ±13   |
| C12668-02            |                               |      |       |
| C12668-03            |                               |      |       |
| C12668-04            |                               |      |       |
| <b>NEW</b> C12668-05 | ±11.9                         |      | ±12.1 |
| <b>NEW</b> C12668-06 |                               |      |       |

\*2: Use a power supply with 200 mA or higher output.

### ➤ Electrical characteristics (Ta=25 °C)

| Type no.             | Current consumption<br>Ic<br>Vs=±12 V<br>(mA) |      |      | Output impedance<br>Zo<br>(Ω) |                  |
|----------------------|---|------|------|-------------------------------|------------------|
|                      | Min.  | Typ. | Max. | OUT terminal                  | Monitor terminal |
| C12668-01            | ±52   | ±60  | ±64  | 50                            | 220              |
| C12668-02            |   |      |      |                               |                  |
| C12668-03            |   |      |      |                               |                  |
| C12668-04            | ±50   | ±54  | ±60  |                               |                  |
| <b>NEW</b> C12668-05 |   |      |      |                               |                  |
| <b>NEW</b> C12668-06 |   |      |      |                               |                  |

### Electrical and optical characteristics (Typ. $T_a=25\text{ }^\circ\text{C}$ , $V_s=\pm 12\text{ V}$ , unless otherwise noted)

| Type no.             | Optimal wavelength band* <sup>3</sup><br>$\lambda_{op}$<br>( $\mu\text{m}$ ) | Photosensitivity SPD<br>$\lambda=\lambda_{op}$<br>(A/W) | Cutoff frequency $f_c$<br>-3 dB<br>(MHz) |                  | Common-mode rejection ratio<br>CMRR* <sup>4</sup><br>(dB) | Conversion impedance $Z_t$<br>(V/A) |                  | Output noise voltage* <sup>5</sup><br>$V_n$<br>(mVp-p) |     |
|----------------------|--|---|--|------------------|---|-------------------------------------|------------------|--|-----|
|                      |  |   | OUT terminal                             | Monitor terminal |   | OUT terminal                        | Monitor terminal | OUT terminal   |     |
|                      |  |   |  |                  |   |                                     |                  | Typ.   | Max |
| C12668-01            | 1.0  | 0.75  | DC to 200                                | DC to 0.1        | 35  | $3 \times 10^4$                     | $1 \times 10^4$  | 20   | 40  |
| C12668-02            | 1.3  | 0.95  |  |                  |   |                                     |                  |  |     |
| C12668-03            | 1.0  | 0.75  | DC to 400                                | DC to 1          | 30  | $1 \times 10^4$                     |                  |  |     |
| C12668-04            | 1.3  | 0.95  |  |                  |   |                                     |                  |  |     |
| <b>NEW</b> C12668-05 | 1.0  | 0.60  | 0.1 to 800                               | DC to 1          | 30  | $5.8 \times 10^4$                   | 80               | 160  |     |
| <b>NEW</b> C12668-06 | 1.3  | 0.85  |  |                  |   |                                     |                  |  |     |

\*3: Wavelength at which multiple reflections can be reduced the most

\*4: Output difference when an approximately 70  $\mu\text{W}$  light is applied to only the INPUT- terminal and when applied to INPUT+ and INPUT- terminals (see the frequency characteristics)

\*5: Dark state, 50  $\Omega$  termination

### Frequency characteristics (measured with network analyzer, typical example)

C12668-01/-02

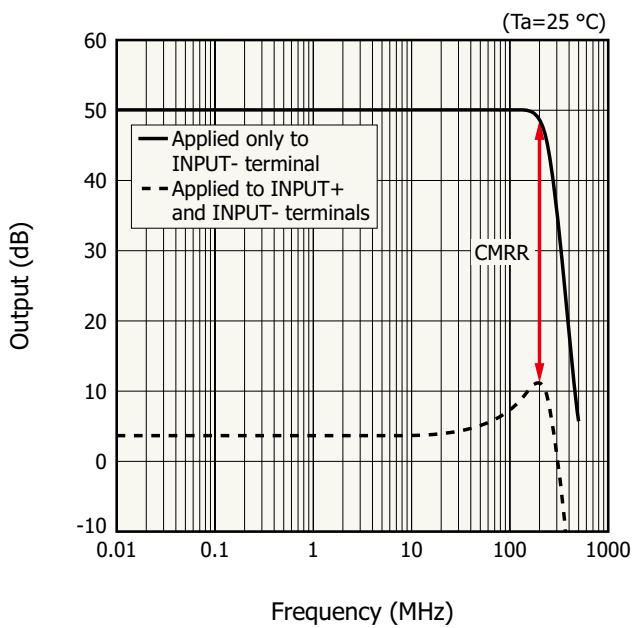

KACCB0358EA

C12668-03/-04

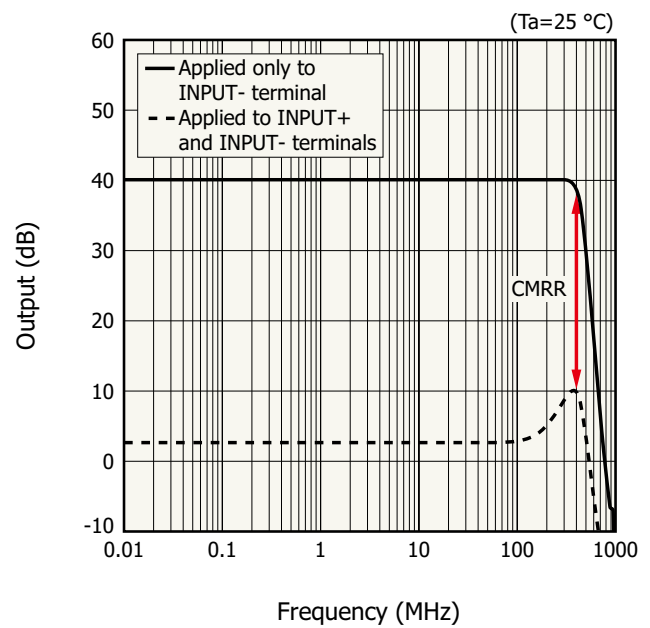

KACCB0463EA

C12668-05/-06

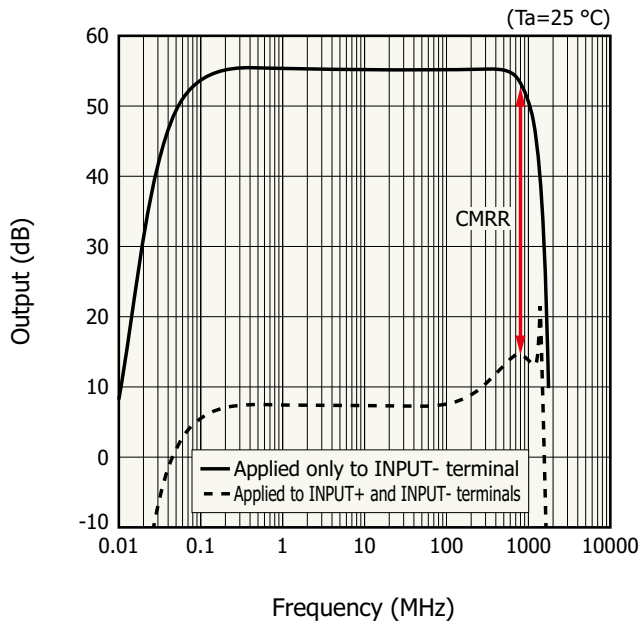

KACCB0674EA

**Block diagram**

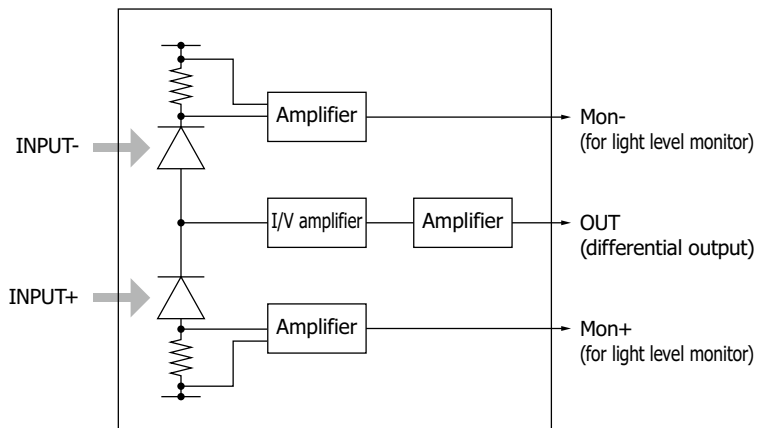

KACCC0761EB

Dimensional outlines (unit: mm)

C12668-01/-02

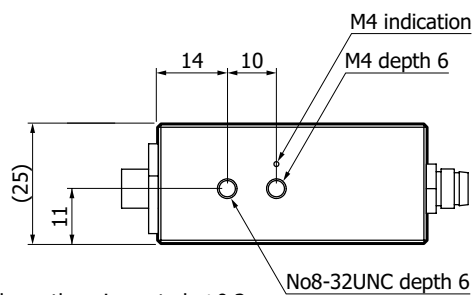
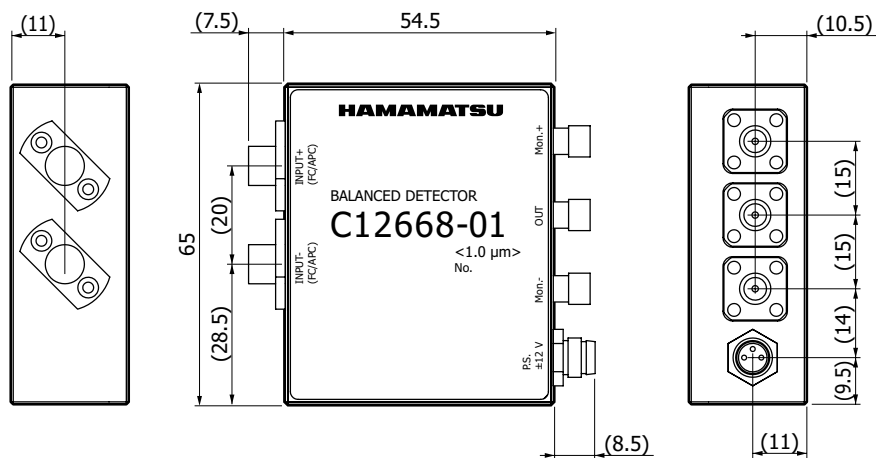

Tolerance unless otherwise noted: ±0.3

KACCA0351EB

C12668-03/-04

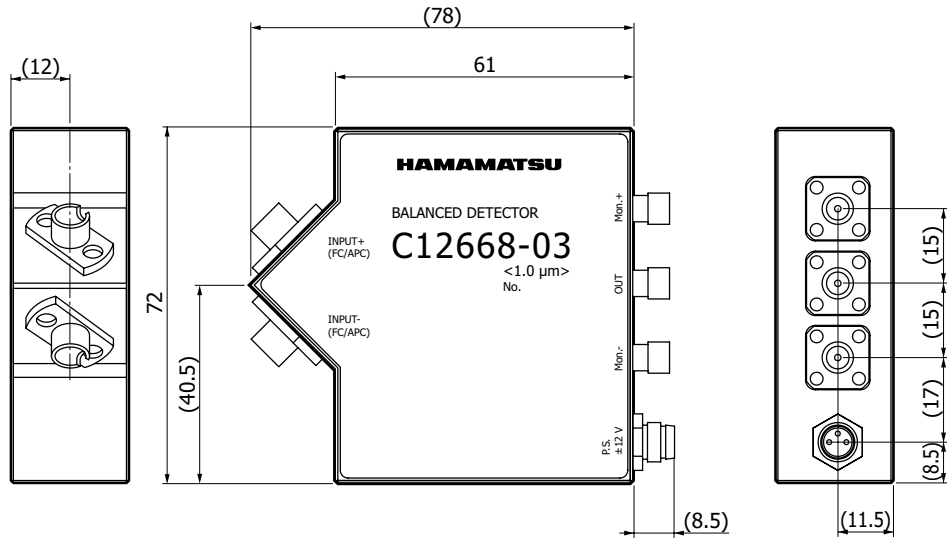

Tolerance unless otherwise noted:  $\pm 0.3$

KACCA0393EA

C12668-05/-06

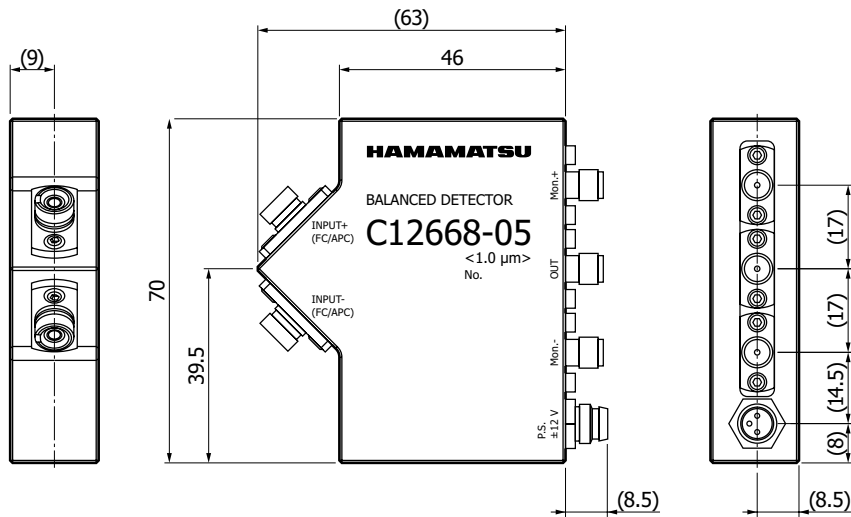

Tolerance unless otherwise noted:  $\pm 0.3$

KACCA0475EA

**Accessory (unit: mm)**

- Cable for power supply (no connector on one end)

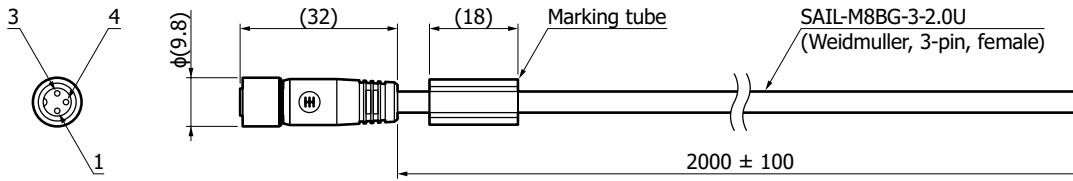

| Pin no. | Wire color    |
|---------|---------------|
| 1       | Brown (+12 V) |
| 3       | Blue (-12 V)  |
| 4       | Black (GND)   |

KACCA0352EB

**Connection example (ophthalmic medical OCT)**

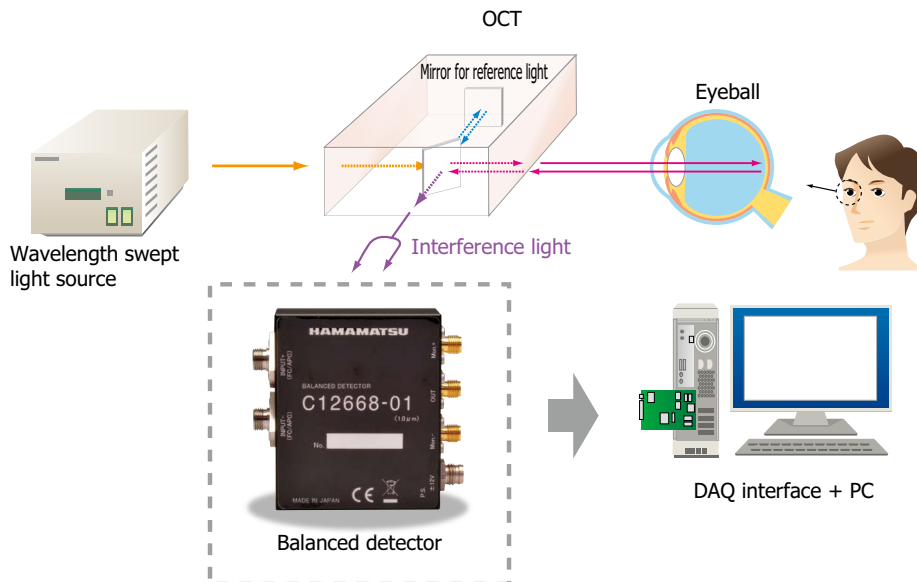

KACCC0762EA

## Related information

[www.hamamatsu.com/sp/ssd/doc\\_en.html](http://www.hamamatsu.com/sp/ssd/doc_en.html)

- Precautions
- Disclaimer

Information described in this material is current as of October 2021.

Product specifications are subject to change without prior notice due to improvements or other reasons. This document has been carefully prepared and the information contained is believed to be accurate. In rare cases, however, there may be inaccuracies such as text errors. Before using these products, always contact us for the delivery specification sheet to check the latest specifications.

The product warranty is valid for one year after delivery and is limited to product repair or replacement for defects discovered and reported to us within that one year period. However, even if within the warranty period we accept absolutely no liability for any loss caused by natural disasters or improper product use. Copying or reprinting the contents described in this material in whole or in part is prohibited without our prior permission.

# HAMAMATSU

[www.hamamatsu.com](http://www.hamamatsu.com)

HAMAMATSU PHOTONICS K.K., Solid State Division

1126-1 Ichino-cho, Higashi-ku, Hamamatsu City, 435-8558 Japan, Telephone: (81)53-434-3311, Fax: (81)53-434-5184

U.S.A.: Hamamatsu Corporation: 360 Foothill Road, Bridgewater, N.J. 08807, U.S.A., Telephone: (1)908-231-0960, Fax: (1)908-231-1218, E-mail: [usa@hamamatsu.com](mailto:usa@hamamatsu.com)

Germany: Hamamatsu Photonics Deutschland GmbH: Arzbergerstr. 10, 82211 Herrsching am Ammersee, Germany, Telephone: (49)8152-375-0, Fax: (49)8152-265-8, E-mail: [info@hamamatsu.de](mailto:info@hamamatsu.de)

France: Hamamatsu Photonics France S.A.R.L.: 19, Rue du Saule Trapu, Parc du Moulin de Massy, 91882 Massy Cedex, France, Telephone: (33)1 69 53 71 00, Fax: (33)1 69 53 71 10, E-mail: [infos@hamamatsu.fr](mailto:infos@hamamatsu.fr)

United Kingdom: Hamamatsu Photonics UK Limited: 2 Howard Court, 10 Tewin Road, Welwyn Garden City, Hertfordshire AL7 1BW, UK, Telephone: (44)1707-294888, Fax: (44)1707-325777, E-mail: [info@hamamatsu.co.uk](mailto:info@hamamatsu.co.uk)

North Europe: Hamamatsu Photonics Norden AB: Torshamnsgatan 35 16440 Kista, Sweden, Telephone: (46)8-509 031 00, Fax: (46)8-509 031 01, E-mail: [info@hamamatsu.se](mailto:info@hamamatsu.se)

Italy: Hamamatsu Photonics Italia S.r.l.: Strada della Moia, 1 int. 6, 20044 Arese (Milano), Italy, Telephone: (39)02-93 58 17 33, Fax: (39)02-93 58 17 41, E-mail: [info@hamamatsu.it](mailto:info@hamamatsu.it)

China: Hamamatsu Photonics (China) Co., Ltd.: 1201 Tower B, Jiaming Center, 27 Dongsanhuan Beilu, Chaoyang District, 100020 Beijing, P.R.China, Telephone: (86)10-6586-6006, Fax: (86)10-6586-2866, E-mail: [hpc@hamamatsu.com.cn](mailto:hpc@hamamatsu.com.cn)

Taiwan: Hamamatsu Photonics Taiwan Co., Ltd.: 8F-3, No. 158, Section2, Gongdao 5th Road, East District, Hsinchu, 300, Taiwan R.O.C. Telephone: (886)3-659-0080, Fax: (886)3-659-0081, E-mail: [info@hamamatsu.com.tw](mailto:info@hamamatsu.com.tw)